

LOS ANGELES WORLD AIRPORTS

Terminal Wayfinding Standards



Contents



1

Introduction 04–06

- S.1 Summary of Sign Types.....04
- S.2 Summary of Sign Types.....05
- 1.1 Purpose.....06

2

Wayfinding 07–08

- 2.1 What is wayfinding.....07
- 2.2 Influencing factors.....08
- 2.3 Benefits of good wayfinding.....08

3

Signage Design Guide 09–17

- 3.1 Signage Systems.....09
- 3.2 Infrastructure Connectivity.....10
- 3.3 Typography.....12
- 3.4 Color Scheme14
- 3.5 Pictograms15
- 3.6 Pathway.....17

C

C_Customs and Border Protection.. 19–25

- C_1 CBP Wall Identity.....19
- C_2 Welcome Identity.....20
- C_3 Carousel Identity.....21
- C_4 CBP Counter Identity.....22
- C_5 CBP Primary Checkpoint.....23
- C_6 Security Regulation.....24
- C_7 Hazmat regulation.....25

G

G_Gates..... 26–31

| | | |
|-----|-------------------------------------|----|
| G_1 | Pier Identity..... | 26 |
| G_2 | Departure Hall Identity..... | 27 |
| G_3 | Gate Identity..... | 28 |
| G_4 | Gate Identity Sterile Corridor..... | 29 |
| G_5 | Counter Identity..... | 30 |
| G_6 | TSA Identity Blade..... | 31 |

M

M_Miscellaneous 32–51

| | | |
|------|--|----|
| M_1 | Room Occupancy..... | 32 |
| M_2 | Life Safety Regulation Identity..... | 33 |
| M_3 | Evacuation Plan Elevator..... | 34 |
| M_4 | Elevator Directory..... | 35 |
| M_5 | Stairwell Identity..... | 36 |
| M_6 | Stair Identity..... | 37 |
| M_7 | Floor Identity..... | 38 |
| M_8 | Area of Assistance Sign..... | 39 |
| M_9 | Area of Evacuation Map/Stair Identity..... | 40 |
| M_10 | Tactile Exit - Wall..... | 41 |
| M_11 | Exit Only No Re-Entry..... | 42 |
| M_12 | Restricted Area - Door..... | 43 |
| M_13 | Poster Frame..... | 44 |
| M_14 | Poster Stanchion..... | 45 |
| M_15 | Poster Stanchion..... | 46 |
| M_16 | Clearance Path..... | 47 |
| M_17 | Clearance Path - Wall..... | 48 |
| M_18 | Clearance Bar..... | 49 |
| M_19 | Clearance - Wall Mounted..... | 50 |
| M_20 | Evacuation Plan Reduced Size..... | 51 |

R

R_Regulatory..... 52–61

| | | |
|------|-------------------------------------|----|
| R_1 | Room Identity..... | 52 |
| R_2 | Multiple Room Identity..... | 53 |
| R_3 | Defibrillator Room Identity..... | 54 |
| R_4 | Defibrillator Identity Vinyl..... | 55 |
| R_5 | General Services Identity..... | 56 |
| R_6 | Restroom Identity Door..... | 57 |
| R_7 | Restroom Identity Wall..... | 58 |
| R_8 | Restroom Identity Door No. | 59 |
| R_9 | General Services Identity Wall..... | 60 |
| R_10 | Wheelchair Accessible Stalls..... | 61 |

W

W_Wayfinding 62–77

| | | |
|------|--|----|
| W_1 | CBP Identity Sign..... | 62 |
| W_2 | Pedestrian Directional - Smaller Overhead..... | 63 |
| W_3 | Pedestrian Directional - Overhead..... | 64 |
| W_4 | CBP Directional Static/Dynamic Overhead..... | 65 |
| W_5 | CSR Static Dynamic Overhead..... | 66 |
| W_6 | Wall Identity..... | 67 |
| W_7 | Pedestrian Directional - Smaller Overhead..... | 68 |
| W_8 | Small Directional - Wall..... | 69 |
| W_9 | Wayfinding Directional - Wall..... | 70 |
| W_10 | Pedestrian Direction - Wall..... | 71 |
| W_11 | Informational Sign Placard..... | 72 |
| W_12 | Directional Sign Placard..... | 73 |
| W_13 | Small Freestanding Directional..... | 74 |
| W_14 | Freestanding Directory..... | 75 |
| W_15 | large Freestanding Directional..... | 76 |
| W_16 | Freestanding Directional..... | 77 |
| W_17 | Pet Relief Station..... | 78 |

Summary of Sign Types



C_1 CBP WALL IDENTITY



C_2 WELCOME IDENTITY

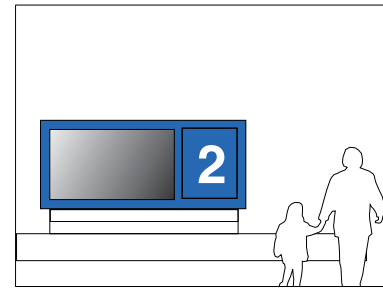

C_3 BID/CAROUSEL ID

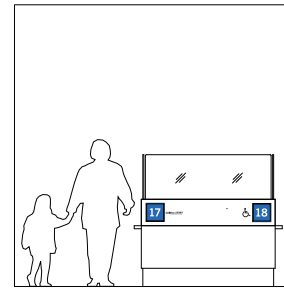

C_4 CBP COUNTER IDENTITY

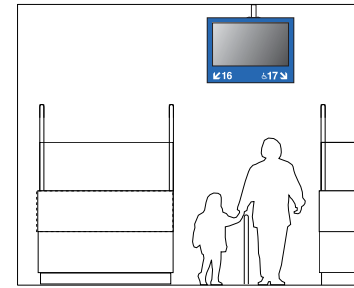

C_5 CBP PRIMARY CHECKPOINT

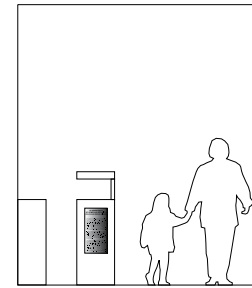

C_6 SECURITY REGULATION

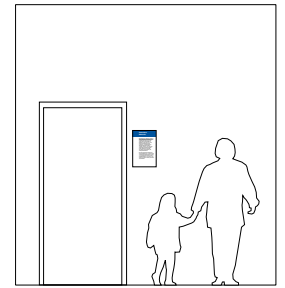

C_7 HAZMAT REGULATION

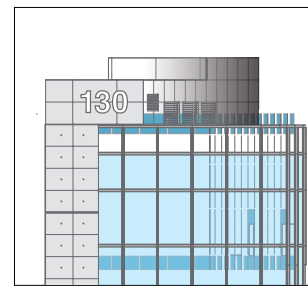

G_1 PIER IDENTITY

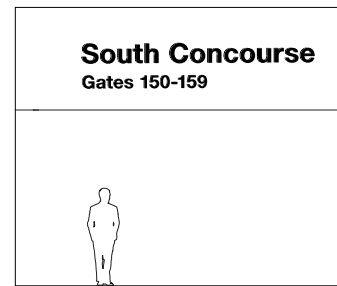

G_2 DEPARTURE HALL IDENTITY

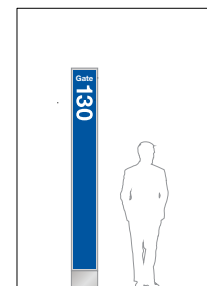

G_3 GATE IDENTITY

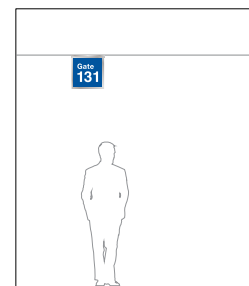

G_4 GATE IDENTITY STERILE CORRIDOR

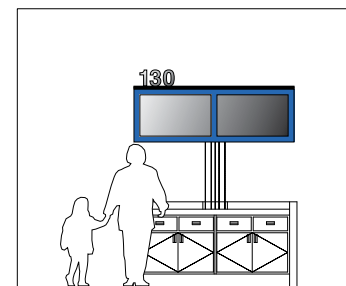

G_5 COUNTER IDENTITY

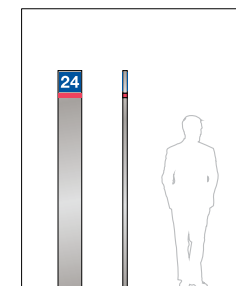

G_6 TSA IDENTITY BLADE

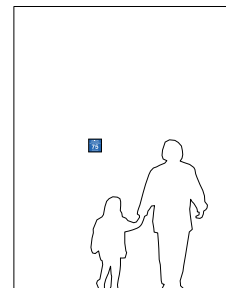

M_1 ROOM OCCUPANCY

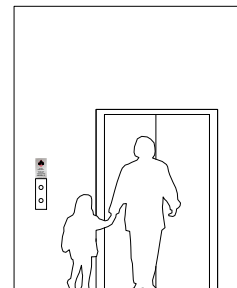

M_2 LIFE SAFETY REGULATORY IDENTITY

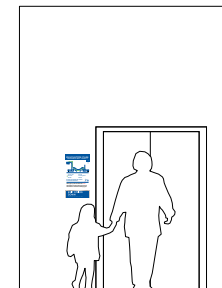

M_3 EVACUATION PLAN ELEVATOR

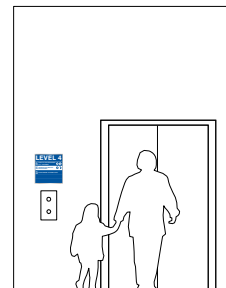

M_4 ELEVATOR DIRECTORY

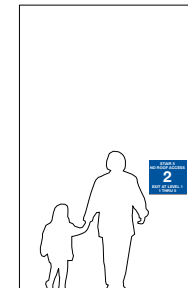

M_5 STAIRWELL IDENTITY

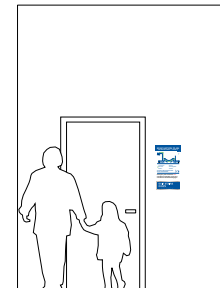

M_6 STAIR IDENTITY

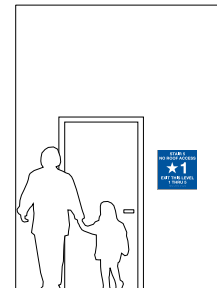

M_7 FLOOR IDENTITY

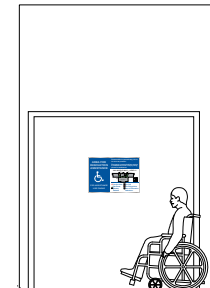

M_8 AREA OF ASSISTANCE SIGN

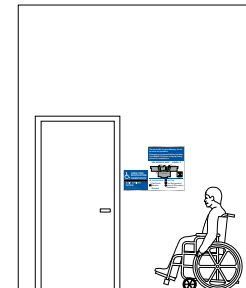

M_9 AREA OF EVAC MAP/STAIR IDENTITY

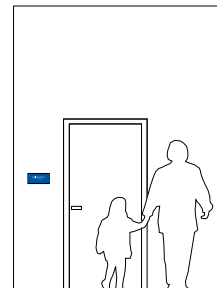

M_10 EXIT ROUTE

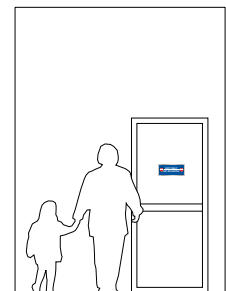

M_11 EXIT ONLY NO RE-ENTRY

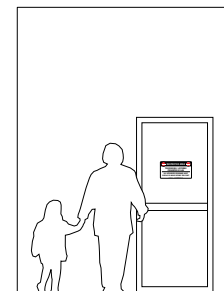

M_12 RESTRICTED AREA - DOOR

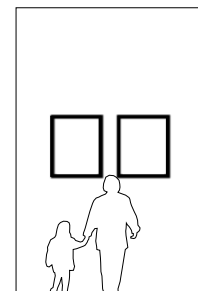

M_13 POSTER FRAME

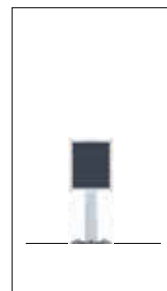

M_14 POSTER STANCHION

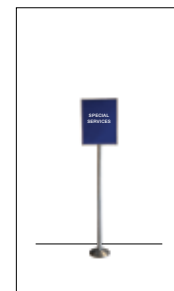

M_15 POSTER STANCHION

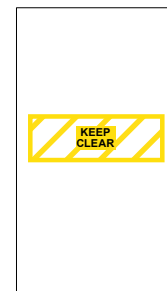

M_16 CLEARANCE PATH

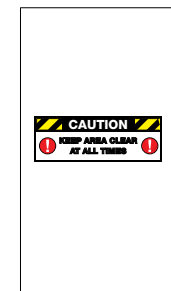

M_17 CLEARANCE PATH WALL

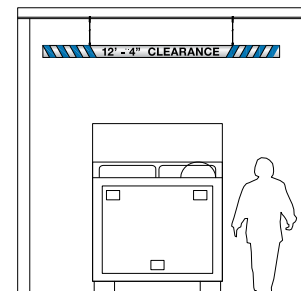

M_18 CLEARANCE BAR

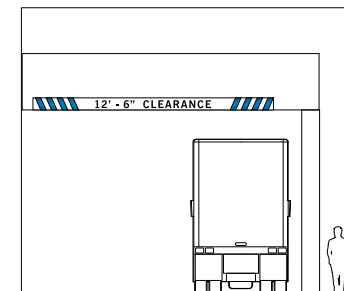

M_19 CLEARANCE - WALL MOUNT

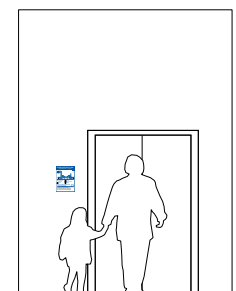

M_20 EVACUATION PLAN REDUCED SIZE

Summary of Sign Types

S.2

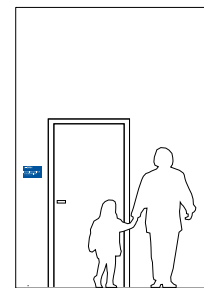

R_1 ROOM IDENTITY

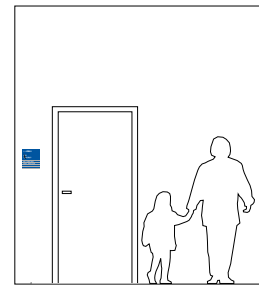

R_2 MULTIPLE ROOM ID

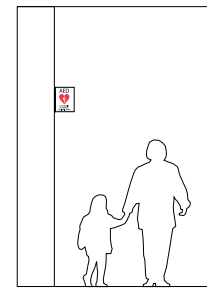

R_3 DEFIBRILATOR IDENTITY BLADE

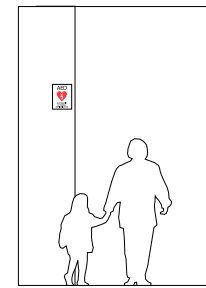

R_4 DEFIBRILATOR IDENTITY VINYL

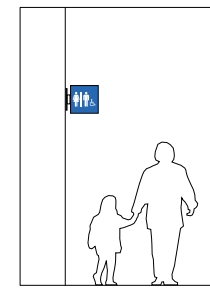

R_5 GENERAL SERVICES IDENTITY

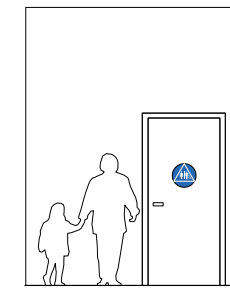

R_6 RESTROOM IDENTITY DOOR (TITLE 24)

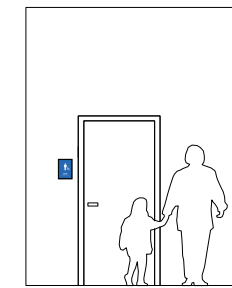

R_7 RESTROOM IDENTITY WALL

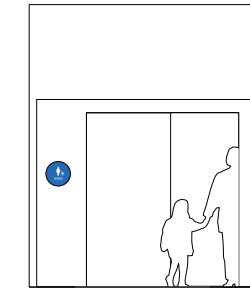

R_8 RESTROOM IDENTITY NO DOOR

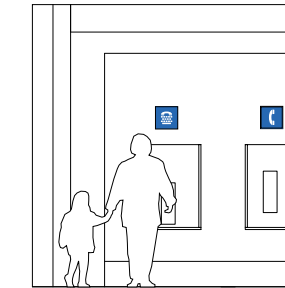

R_9 GENERAL SERVICES IDENTITY - WALL

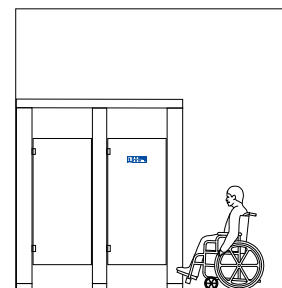

R_10 RESTROOM IDENTITY PRIORITY STALL

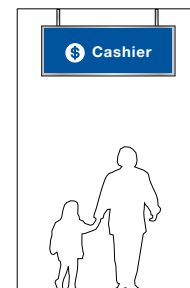

W_1 CBP IDENTITY

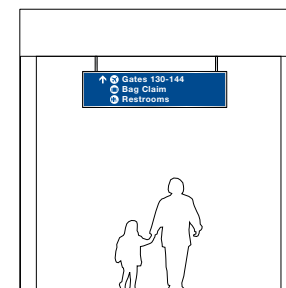

W_2 PEDESTRIAN DIRECTIONAL - SMALLER OVERHEAD

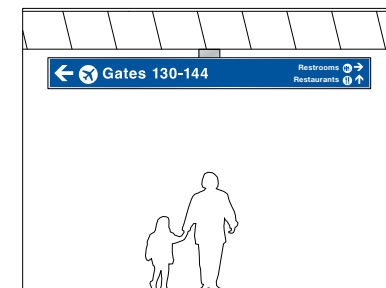

W_3 PEDESTRIAN DIRECTIONAL - OVERHEAD

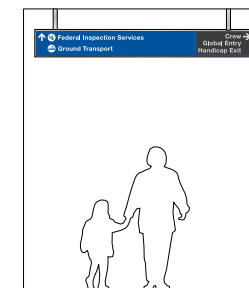

W_4 CBP DIRECTIONAL STATIC/DYNAMIC OVERHEAD

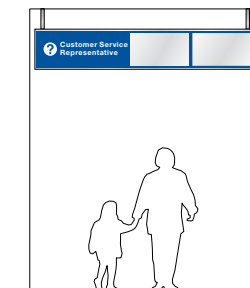

W_5 CSR STATIC DYNAMIC OVERHEAD

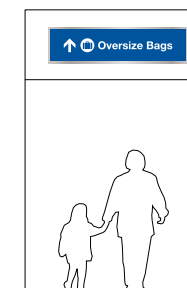

W_6 WALL IDENTITY

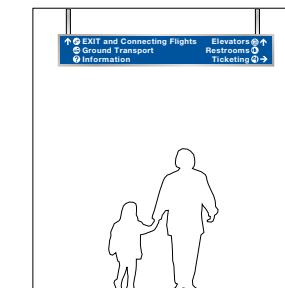

W_7 PEDESTRIAN DIRECTIONAL - SMALL OVERHEAD



W_8 SMALL DIRECTIONAL - WALL

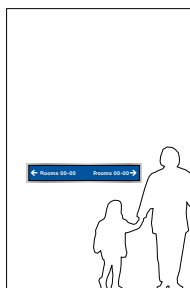

W_9 WAYFINDING DIRECTIONAL - WALL

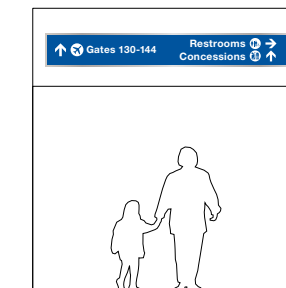

W_10 PEDESTRIAN DIRECTIONAL - WALL

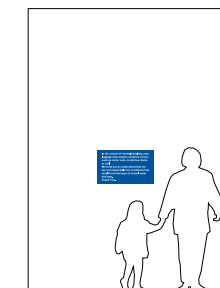

W_11 INFORMATION SIGN PLACARD

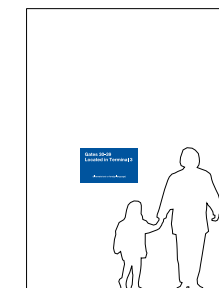

W_12 DIRECTIONAL SIGN PLACARD

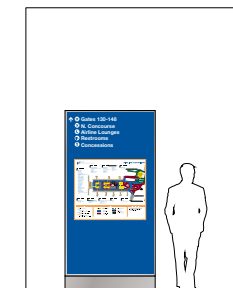

W_13 SMALL FREESTANDING DIRECTIONAL

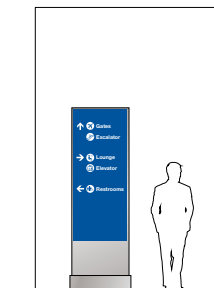

W_14 FREESTANDING DIRECTORY

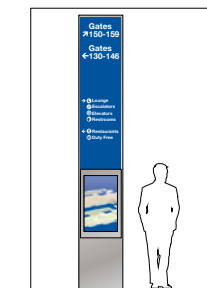

W_15 LARGE FREESTANDING DIRECTIONAL

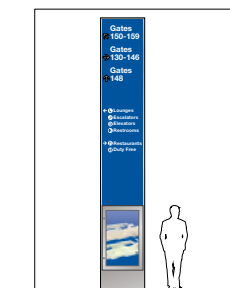

W_16 FREESTANDING DIRECTORY

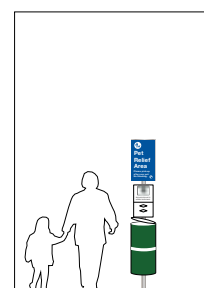

W_17 PET RELIEF STATION

1

INTRODUCTION

1.1

Purpose

The Terminal Wayfinding Standards for Los Angeles World Airports has been developed to assist the industry involved in delivering wayfinding information to travellers at Los Angeles International Airport.

The Standards includes information and advice on wayfinding practices as well as guidance on designing signs. It is intended to provide a reference and instruction on the important aspects of wayfinding as well as sources for more detailed and specific information.

The use of the Standards should be taken into consideration in wayfinding planning activities throughout all terminals at LAX. Any variations to the guidelines should be presented to the proper department for approval.

All signs in these standards are in compliance with the current ADA guidelines that regulates the size of symbols and accompanying text. To further aid the traveling public, LAWA emphasizes the use of international symbols on its wayfinding. TBIT West signs currently have smaller pictograms. Super graphics incorporating international symbols can be utilized as a wayfinding aid supplementing the existing signage to make the path of travel an intuitive experience.

2

WAYFINDING



2.1

What is Wayfinding

Wayfinding can be defined as a process in which people navigate an environment using information support systems such as architectural clues, lighting, sight lines and signage.

Successful wayfinding systems can be measured by how travellers experience the airport environment and how the information facilitates self-navigation from point A to point B. Wayfinding systems should create a welcoming and enjoyable environment, reassure travellers and provide answers to questions before they have to ask for assistance.

Wayfinding is achieved by focussing on the travellers needs, especially during the planning and design phases, and encompasses environmental factors, building design, user expectation and signage information.

Wayfinding systems should provide the following information to travellers:

- identify their location
- reinforce they are travelling in the right direction
- identify their destination on arrival (of each area)
- know where to exit safely in an emergency

Wayfinding information can be delivered through the following:

- dynamic information
- static signs
- temporary information
- lighting
- building design
- user's prior knowledge and experience
- staff
- audible information

2.2

Influencing Factors

HUMAN

These are the factors concerned with the individual and their ability to interpret wayfinding information being conveyed to them. This is influenced by their experience in the airport environment and their familiarity with the type of information they encounter. Inexperienced travellers tend not to have a good understanding of how to move through an airport and will look for more information.

When a person is unable to locate the information they require, they will seek alternative sources such as asking staff. People are unable to store a lot of information in their short term memory and they may ignore important information when they are unable to distinguish it from other less relevant information.

INFORMATION

The type of information provided to travellers (visual, audible or physical) and how they interpret and understand this information will affect how they find their way through the airport.

Wayfinding information that is similar to other airport information may be confusing and should be avoided wherever possible. Travellers should be able to distinguish wayfinding information from other types of information, such as operational or advertising.

ENVIRONMENT

An airport's physical layout and architectural features will also influence successful wayfinding. Providing information and reassurance at decision points will help travellers make decisions. The use of sight lines and other visual clues will also aid wayfinding.

2.3

Benefits of Good Wayfinding

Travellers need consistent, concise, accurate and timely information when they are in the airport environment. If a traveller is unable to find their way it can lead to frustration and a poor experience.

Good wayfinding can offer a number of benefits, including:

- traveller satisfaction
- reduce clutter and unnecessary information in the airport environment
- aid traveller flow and reduce airport crowding
- assist travellers get to their flights on time
- allows travellers to reach their destination easily and quickly, allowing them time to explore their environment (e.g. shopping, eating, relaxing)
- reduce enquiries to airport staff

3 SIGNAGE DESIGN GUIDE

3.1

Signage Systems

The primary purpose of an airport sign system is to move travellers through the airport using a concise and comprehensive system of directional, operational, informational and regulatory messages.

The following are sign design guidelines for use at all of the Los Angeles International Airport terminals.

Signs should be positioned to ensure consistency, visual clutter is reduced and travellers are presented with key information at critical decision making points.

Avoid positioning several contrasting signs in close proximity to each other. Signs and posters should not compete with other signs for the user's visual attention.

Provide travellers with key information at critical decision making points. To support decision making, travellers need clear directions at decision points.

GENERAL REQUIREMENTS FOR INFRASTRUCTURE

Admonition to Environmental Graphics Designers

When working for Los Angeles World Airports (LAWA), designers must adhere to the following procedures during the design phases of all signage projects. All submittals shall conform to the design direction set forth in this design manual.

It is expected and required that all environmental graphics designers participating in any graphics/signage projects with LAWA ensure that all work associated with the fabrication and installation of the signage maintain its aesthetic integrity.

LAWA requires implementation of a wayfinding strategy that is based primarily upon dynamic and digital information platforms, complemented by static signage and graphics.

Engineering services must be retained for the purpose of graphics/signage construction in order for documentation to be complete and thorough. This documentation includes, but is not limited to structural, electrical, data, and any other engineering services required for the successful implementation of the graphics/signage program.

It shall be the responsibility of the engineering/fabricating team to perform the complete review of the sign's infrastructure connections and to incorporate all the reasonable safety factors necessary to protect the Owner and their representatives, against public liability.

All electrical and data requirements shall be identified by an electrical engineer, licensed in the State of California and will provide all "panel to install locations" specifications and circuitry information.

The sign fabricator will review all types of signs, messages, and graphics that are indicated on the design drawings and specifications, and confirm various materials, finishes, electrical and data requirements. The structural design and calculations for all signage will require certification by an Engineer licensed in the State of California. The fabricator will complete the structural design of the signs and coordinate with the engineer and/or general contractor for infrastructure connections.

Submittal documents (shop drawings) shall be complete in application, size, details, materials and specifications and reflect the sign types and designs described in this manual. The Engineering team will coordinate with the sign fabricator and the general contractor on all infrastructure footings, structural attachments, and penetrations of slabs in new and existing building conditions.

Infrastructure Connectivity Details

3.2

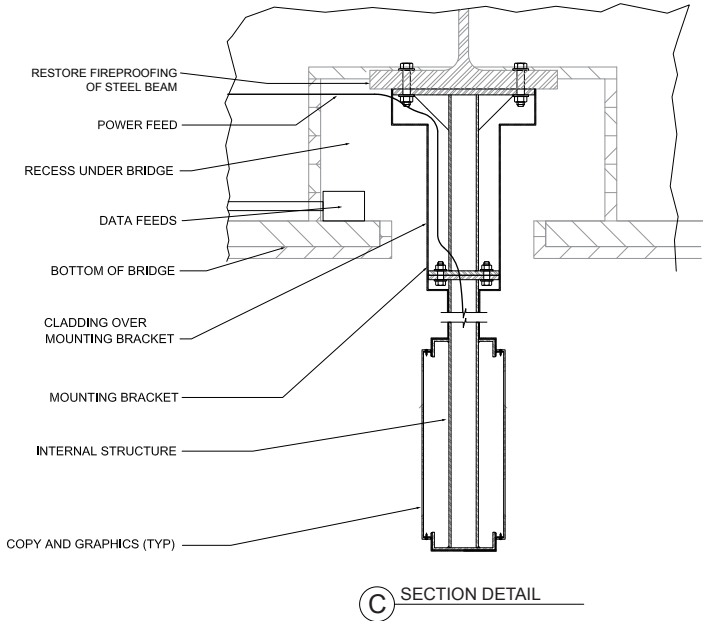
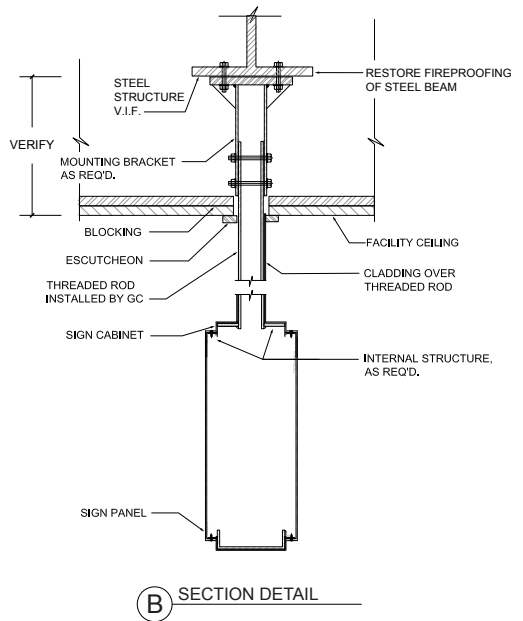
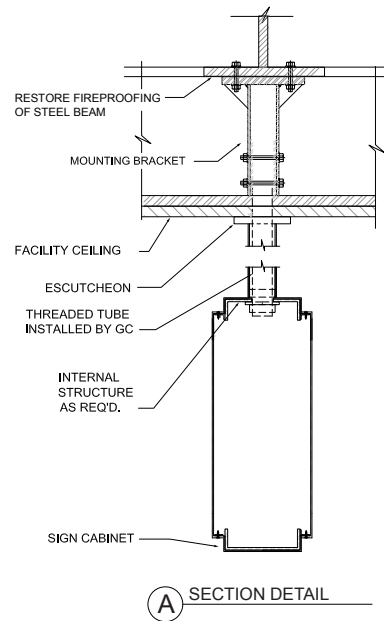

CEILING CONNECTION CONFIGURATION OPTIONS

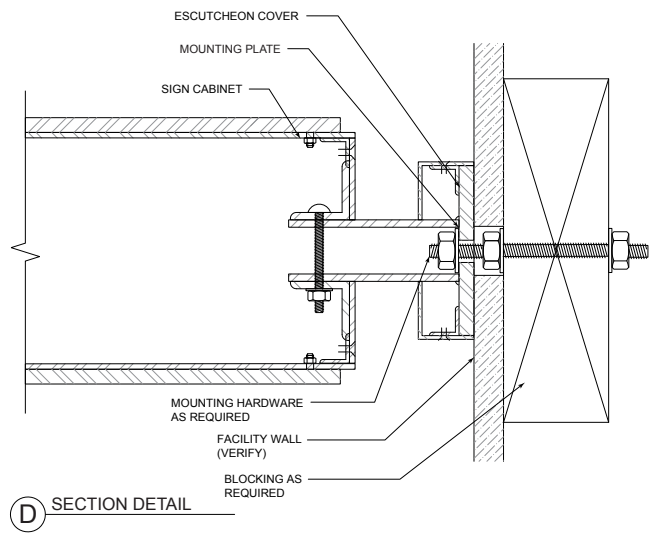

WALL CONNECTION CONFIGURATION OPTIONS

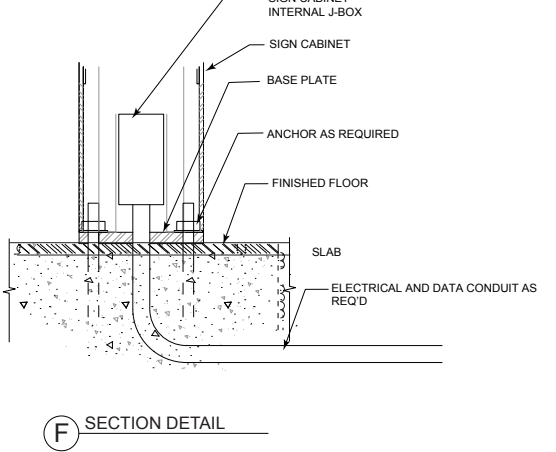
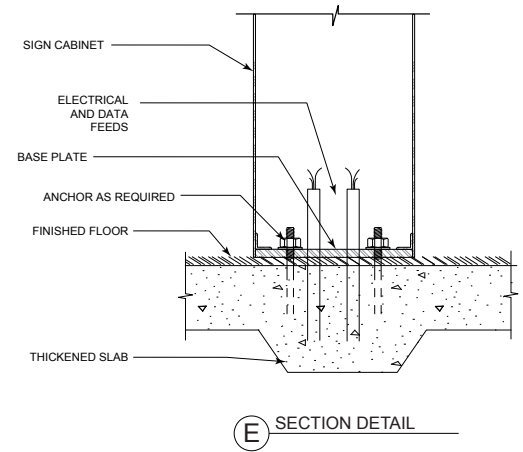

FLOOR CONNECTION CONFIGURATION OPTIONS

Helvetica Neue Lt
Pro 65 Medium

**abcdefghijklmnopqrstuvwxyz
ABCDEFGHIJKLMNOPQRSTUVWXYZ
0123456789 !@#\$%^&*()**

Helvetica Neue Lt
Pro 75 Bold

**abcdefghijklmnopqrstuvwxyz
ABCDEFGHIJKLMNOPQRSTUVWXYZ
0123456789 !@#\$%^&*()**

Franklin Gothic ITC
BY BT – Demi

abcdefghijklmnopqrstuvwxyz
ABCDEFGHIJKLMNOPQRSTUVWXYZ
0123456789 !@#\$%^&*()

Joanna MT
Semibold Regular

abcdefghijklmnopqrstuvwxyz
ABCDEFGHIJKLMNOPQRSTUVWXYZ
0123456789 !@#\$%^&*()

Los Angeles World Airports
Terminal Wayfinding Standards
Signage Design Guide

Paint

NOTE: CONTRACTED GRAPHICS DESIGNER IS TO PROVIDE TERMINAL SPECIFIC COLORS WITH PAINT SPECIFICATIONS FOR EACH SIGNAGE PACKAGE FOR REVIEW AND APPROVAL. DESIGNER TO PROVIDE THREE(3) PAINT SAMPLES OF EACH COLOR PROPOSED. MINIMUM SIZE FOR COLOR SAMPLES IS 3"X3".

Materials

NOTE: CONTRACTED GRAPHICS DESIGNER IS TO PROVIDE TERMINAL SPECIFIC MATERIALS WITH SPECIFICATIONS FOR EACH SIGNAGE PACKAGE FOR REVIEW AND APPROVAL. DESIGNER TO PROVIDE THREE(3) PAINT SAMPLES OF EACH FINISH AND MATERIAL PROPOSED. MINIMUM SIZE FOR SAMPLES IS 6"X6".



Pictograms

Roadway



TAXI

GROUND TRANSPORT

CAR RENTAL

LAX TRANSPORTATION

BUS

GATES

CONNECTING FLIGHT

DEPARTING FLIGHTS

ARRIVING FLIGHTS

International Travel



CUSTOMS

AGRICULTURE

IMMIGRATION

Accessible

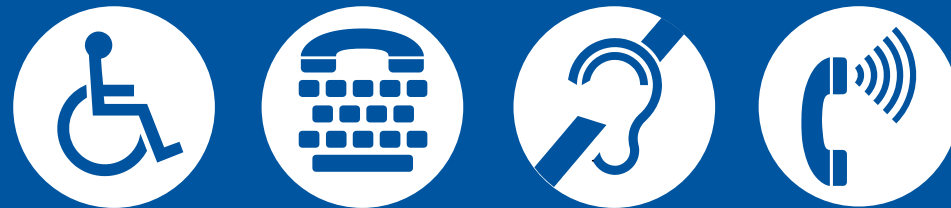

ACCESSIBLE

TTY

HEARING LOSS

VOLUMN CONTROL TELEPHONE

Emergency

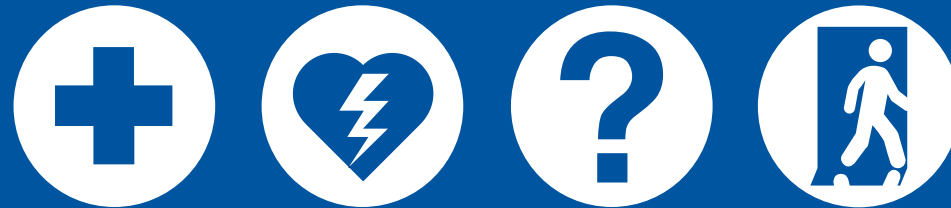







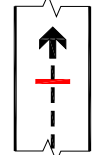
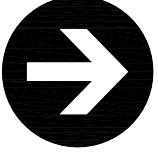
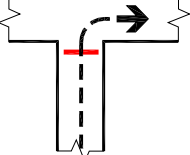
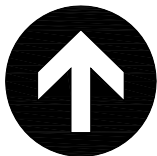
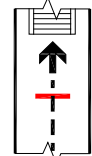
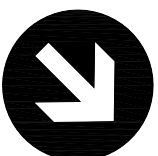
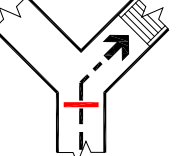

FIRST AID

DEFIBRILLATOR

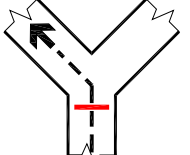
INFORMATION

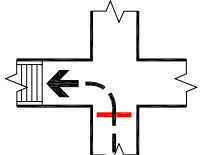
EXIT

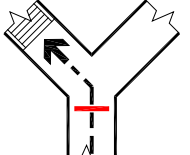
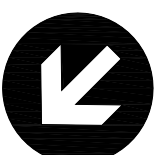
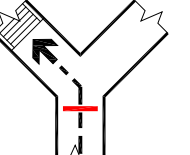
* Where pictograms are provided as designations of permanent interior rooms and spaces, they shall comply with requirements for minimum field height, finish and contrast, and they shall be accompanied by compliant tactile (raised letter and braille) descriptors. Directional and informational pictograms are not required to have tactile descriptors.

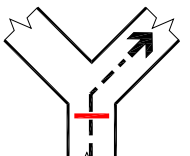
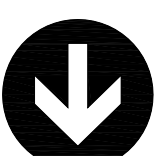
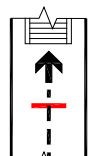
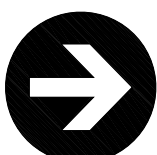
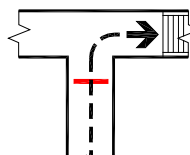
| APPLICATION/ ORIENTATION | LOCATION PLAN | INTERPRETATION | APPLICATION/ ORIENTATION | LOCATION PLAN | INTERPRETATION |
|---|---|----------------|---|---|----------------|
|  |  | STRAIGHT AHEAD |  |  | RIGHT |
|  |  | UP |  |  | DOWN ON RIGHT |
|  |  | AHEAD ON LEFT |  |  | LEFT |
|  |  | UP ON LEFT |  |  | DOWN ON LEFT |
|  |  | AHEAD ON RIGHT |  |  | DOWN |
|  |  | UP ON RIGHT | | | |

Decision Point Diagram

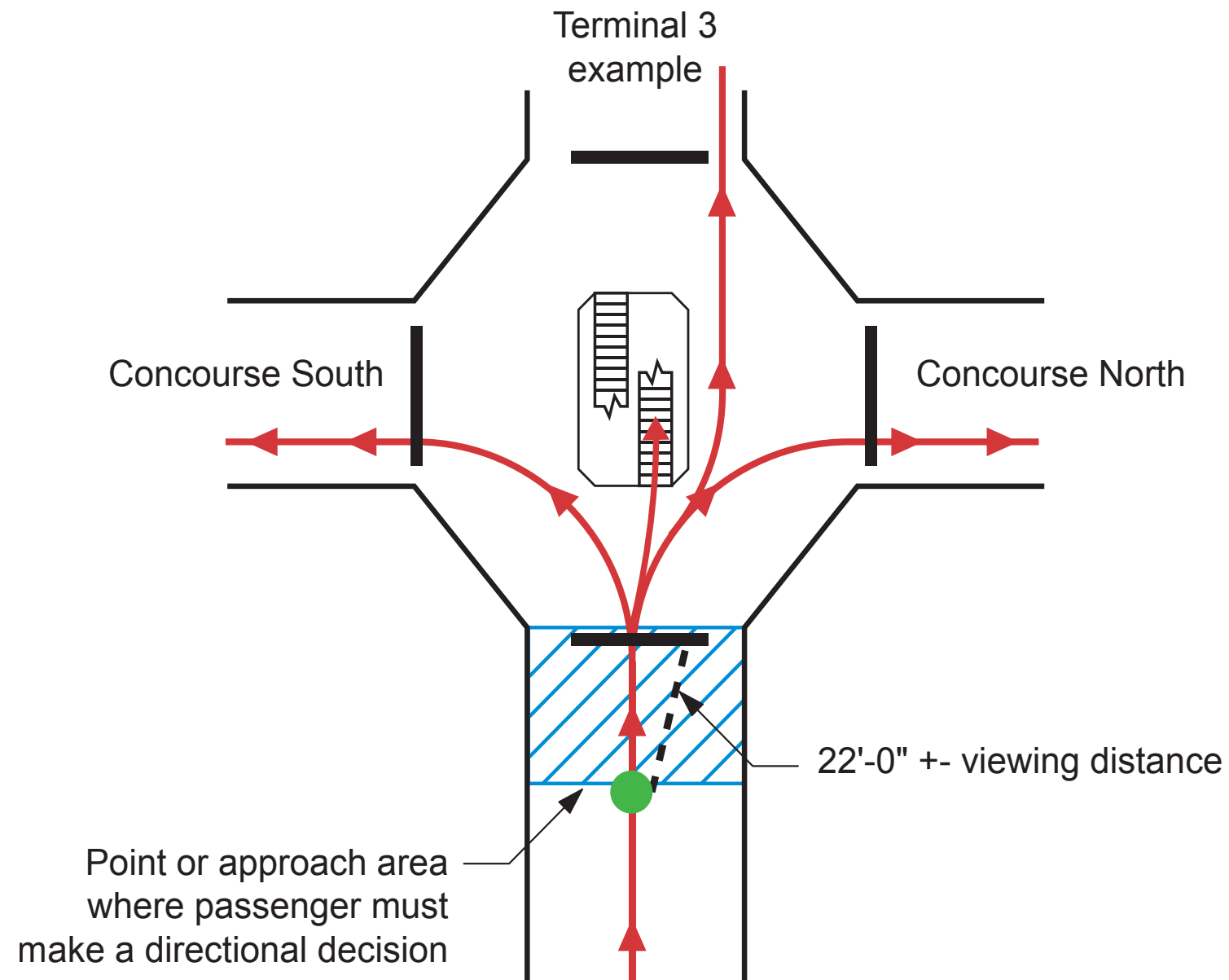

Minimum font heights when viewed from distance:

- 20' - 3"
- 25' - 3 3/4"
- 30' - 4 1/2"

- Sign
- Decision point
- Sight line
- ← Circulation path

NOTE: CBP SIGNAGE MAY BE REQUIRED IN THE TERMINALS.
CONTACT THE FOLLOWING FOR DETAILED SIGNAGE INFORMATION AND
STANDARDS.

CUSTOMS & BORDER PROTECTION GENERAL PRINTING & GRAPHICS
(202) 344-1310

CUSTOMS & BORDER PROTECTION MISSION SUPPORT
(562) 980-3140 ext.102

welcome to
THE UNITED STATES OF AMERICA

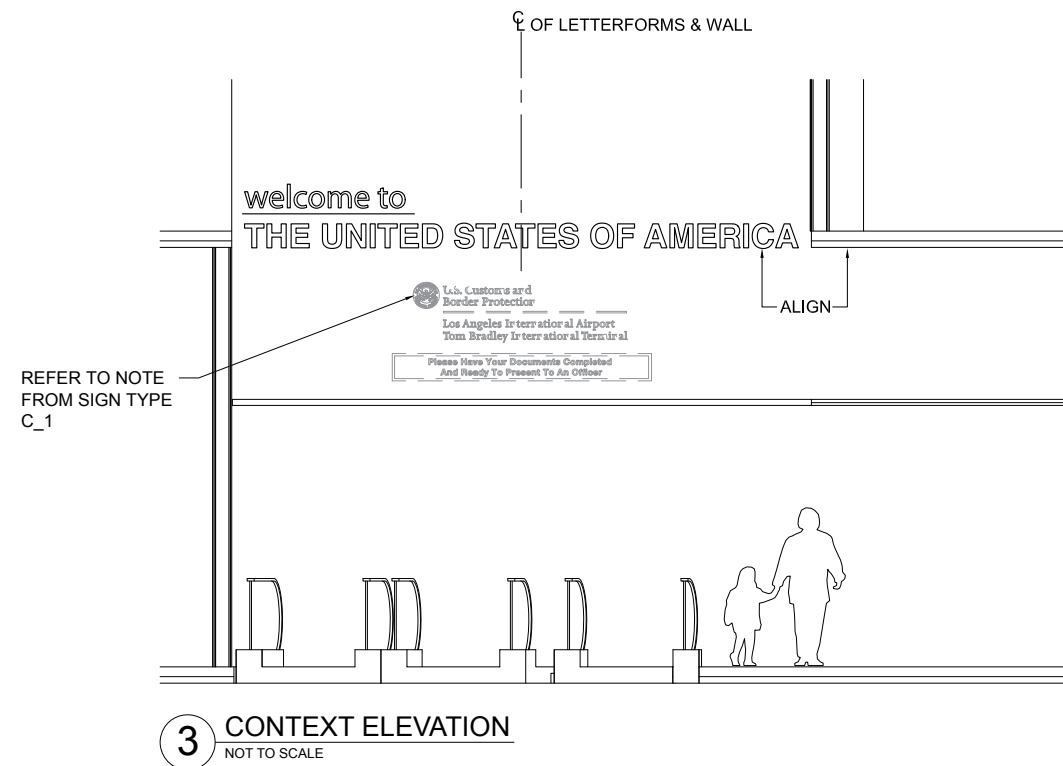

GENERAL NOTES:

1. FABRICATED ALUMINUM LETTERFORMS AND LOGO.
2. LETTER FACES AND RULE LINES TO BE VERTICAL BRUSHED FINISH WITH MIRROR POLISHED RETURNS.
3. 3" THICK LETTERFORMS AND RULE TO BE PIN MOUNTED 1/2" FROM FACILITY WALL WITH THREADED WELDED STUDS, PAINTED NON-CORROSIVE SPACERS AND EPOXY ADHESIVE.
4. VERIFY WALL CONSTRUCTION PRIOR TO FABRICATION OF SIGN.
5. SIGNAGE SHOWN IS FOR PLACEMENT PURPOSES ONLY. FINAL MESSAGE AND LOCATION OF SIGN TO BE PROVIDED BY LAWA.

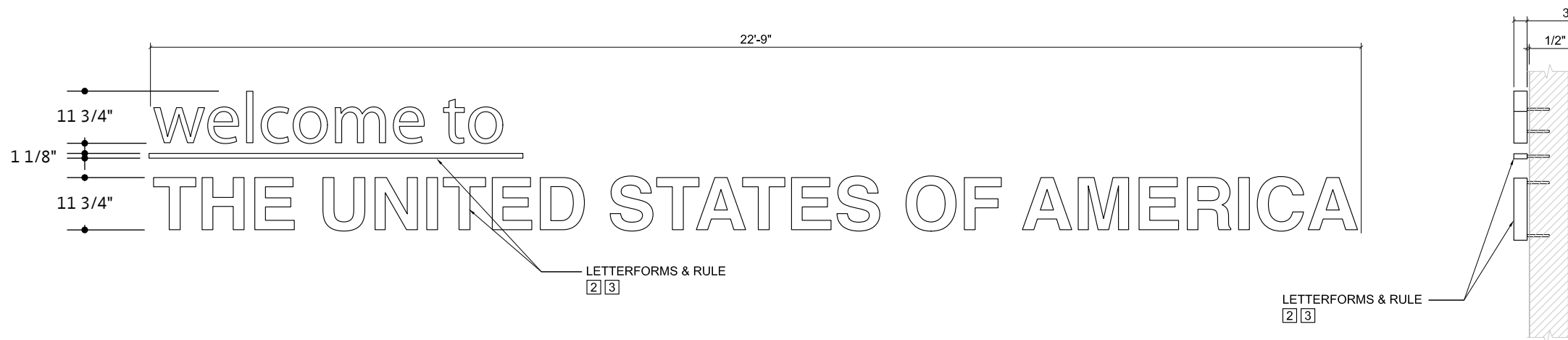

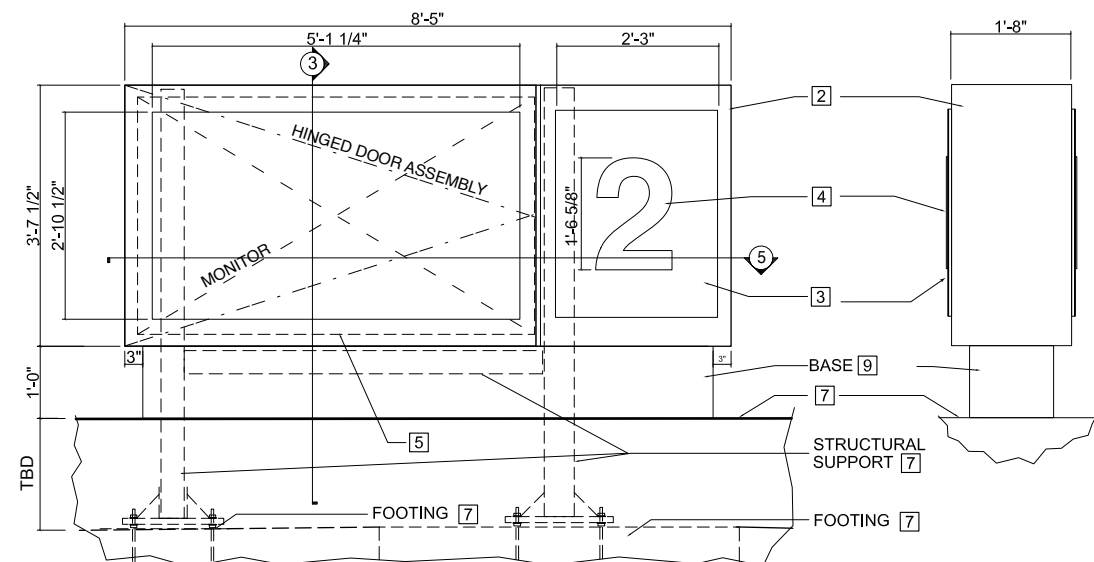
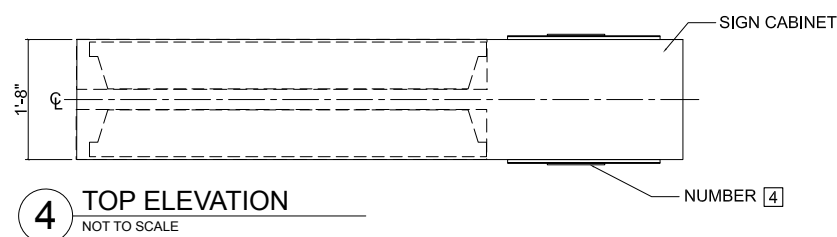
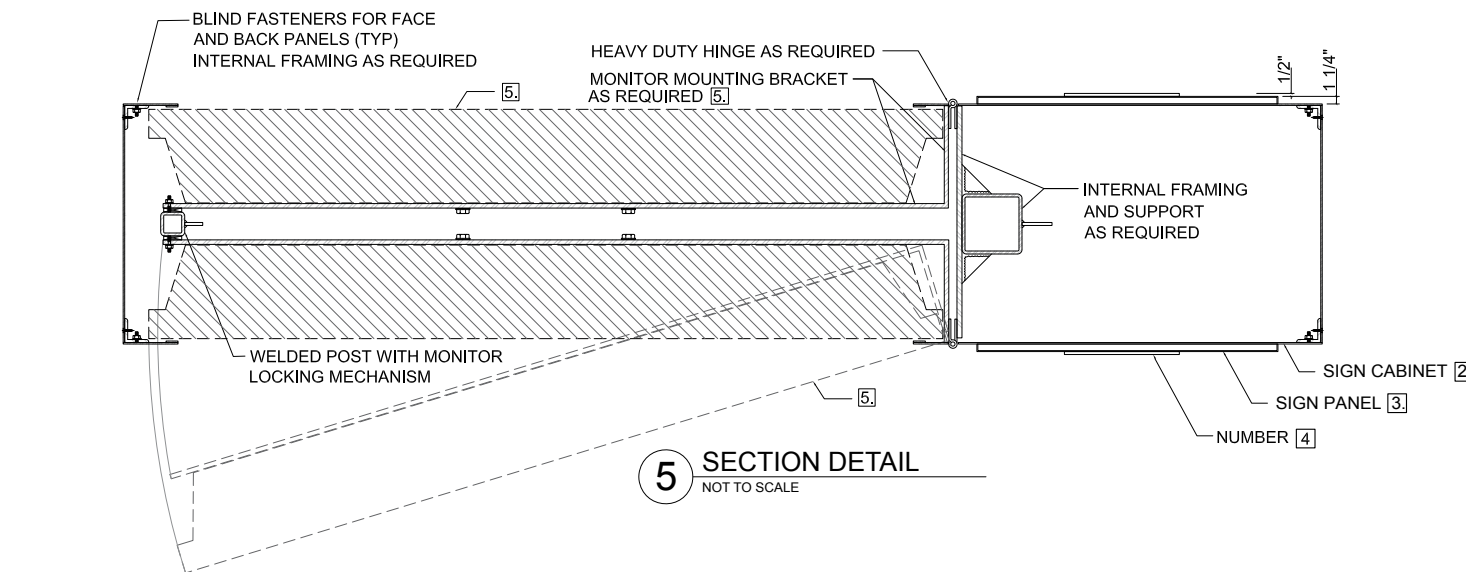

GENERAL NOTES:

1. DOUBLE SIDED SIGN CABINET WITH LCD DISPLAYS.
2. SIGN CABINET TO HAVE INTERNAL FRAMING AND CLADDED WITH BRUSHED ALUMINUM. PROVIDE INCONSPICUOUS ACCESS AS REQUIRED FOR EASE OF MAINTENANCE. EXPOSED EDGES OF ALUMINUM TO BE POLISHED.
3. FABRICATED ALUMINUM SIGN PANEL PAINTED IN COLOR NOTED.
4. NUMERALS TO BE FLAT-CUT-OUT ALUMINUM WITH PAINT FINISH AS NOTED. ADHERE TO SIGN PANEL WITH HIDDEN MECHANICAL FASTENERS.
5. LCD ARRAY DYNAMIC DISPLAY SCREENS TO BE PROVIDED BY LAW/GC (EXAMPLE: NEC P701 70" - USE CURRENT SPECIFICATION). INSTALL INTO SIGN CABINET IN A MANNER TO ALLOW EASE OF MAINTENANCE. MONITORS TO BE LOCKED INTO PLACE. COORDINATE WITH LAW/GC FOR DISPLAY REQUIREMENTS. WEIGHT OF MONITORS IS APPROXIMATELY 220 LBS EACH. PROVIDE APPROPRIATE STRUCTURAL SUPPORT AS REQUIRED BY STRUCTURAL ENGINEERING CALCULATIONS. DETAIL SHOWN IS ONLY A SUGGESTION.
6. FINAL MESSAGE PER SIGN LOCATION TO BE PROVIDED BY LAW.
7. DESIGNER TO FIELD VERIFY AND DETERMINE BEST METHOD OF INSTALLATION. DESIGNER TO PROVIDE STRUCTURAL ENGINEERING CALCULATIONS AS REQUIRED AND COORDINATE WITH GENERAL CONTRACTOR FOR STRUCTURAL REQUIREMENTS.
8. TOTAL APPROXIMATE WEIGHT: 850 LBS.
TOTAL APPROXIMATE WATTAGE REQUIREMENT: 1500W
9. SIGN CABINET BASE TO BE CLADDED WITH BRUSH FINISHED ALUMINUM.

NOTE:

ALL TEXT MUST COMPLY WITH THE ADA STANDARDS, INCLUDING FONT SIZE, COLOR CONTRAST AND READABILITY FROM A DISTANCE.



Sign Type Design

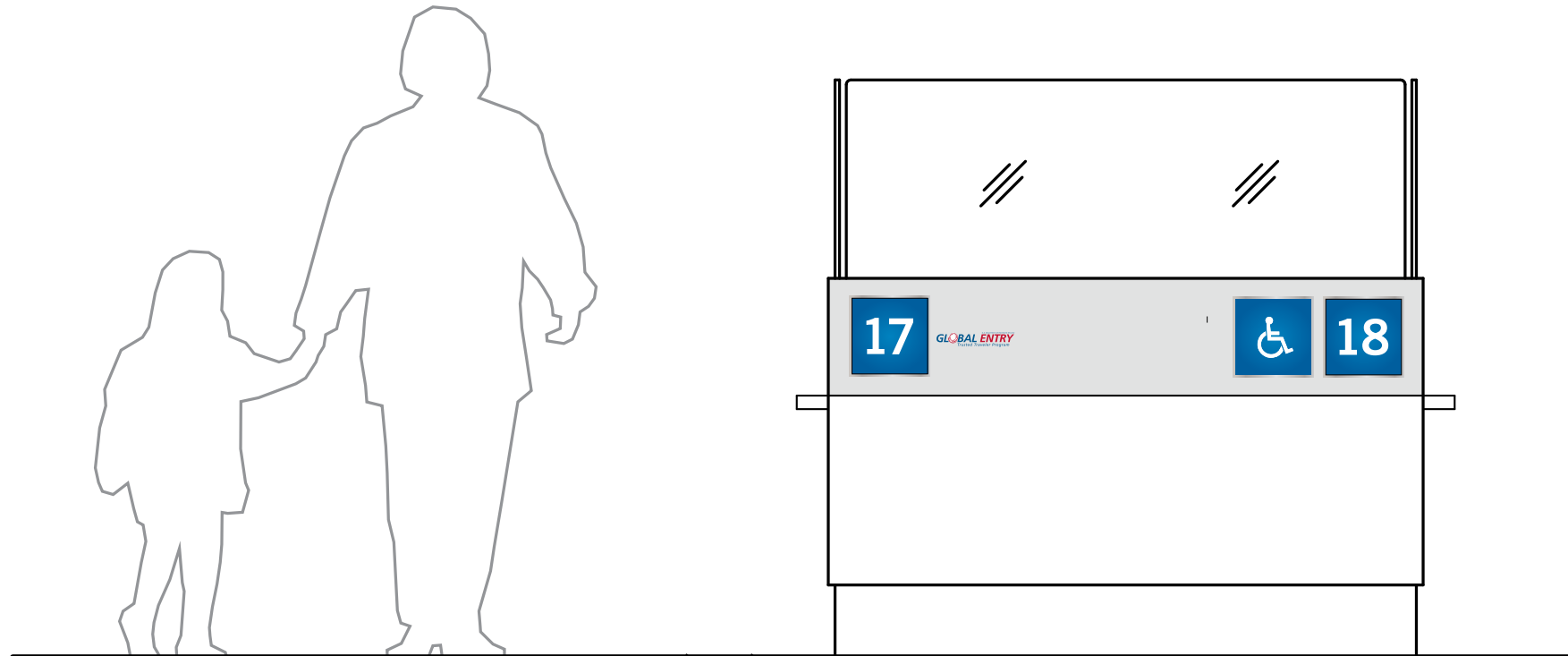

GENERAL NOTES:

1. NON-ILLUMINATED IDENTIFICATION NUMBER PLAQUES AND APPLIED VINYL LOGOS.
2. SIGN PANEL BACKGROUND TO BE ALUMINUM WITH BRUSHED FINISH.
3. SIGN PANEL TO BE PAINTED ALUMINUM PERMANENTLY ATTACHED TO SIGN BACKGROUND.
4. NUMERALS TO BE FLAT-CUT-OUT PAINTED 1/8" ALUMINUM AND APPLIED TO SIGN PANEL WITH ALIGNMENT PINS AND ADHESIVE AS REQUIRED.
5. GRAPHIC LOGOS (WHERE OCCURS) TO BE APPLIED VINYL. "GLOBAL ENTRY" LOGO TO FOLLOW CBP GUIDELINES. REFER TO CBP.GOV FOR INFORMATION. LAWA TO PROVIDE SPECIFIC LOGO LOCATIONS.
6. SIGN TO BE MOUNTED TO PODIUM WITH THREADED WELDED STUDS AND SILICONE ADHESIVE AS REQUIRED.
7. FINAL MESSAGE PER SIGN LOCATION TO BE PROVIDED BY LAWA.

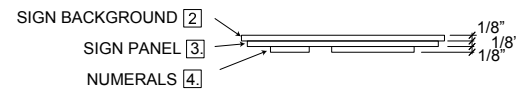

2 DETAIL PLAN VIEW
NOT TO SCALE

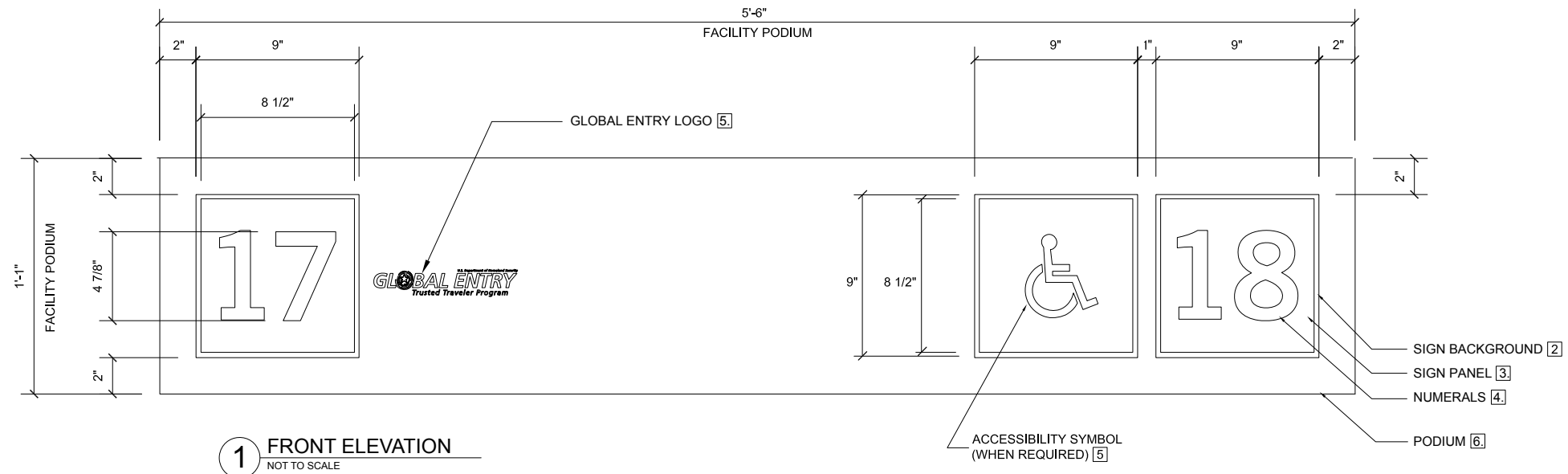

1 FRONT ELEVATION
NOT TO SCALE

CBP Primary Checkpoint

C_5

Sign Type Design

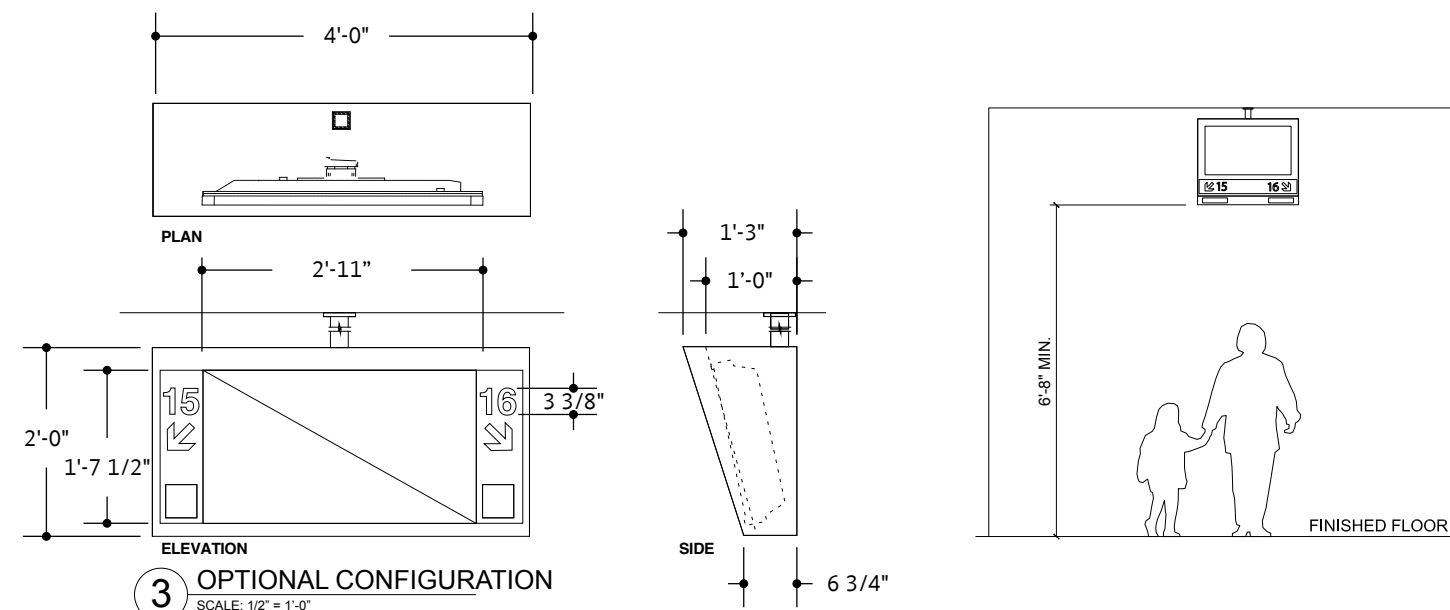

3 OPTIONAL CONFIGURATION
SCALE: 1/2" = 1'-0"

GENERAL NOTES:

1. CEILING MOUNTED DISPLAY MONITOR INCASED IN A FABRICATED ALUMINUM CABINET WITH INTERNAL ILLUMINATION FOR NUMERALS, ARROWS, AND RED/GREEN LIGHTING.
2. MONITOR TO BE NEC 40" #P401 AND SUPPLIED BY OWNER. PROVIDE AND INSTALL MOUNTING BRACKET AS REQUIRED BY STRUCTURAL ENGINEERING CALCULATIONS.
3. CABINET AND SHROUD TO BE FABRICATED WITH BRUSHED ALUMINUM AND HAVE INTERNAL FRAMING AS REQUIRED. PROVIDE INCONSPICUOUS ACCESS PANELS FOR MAINTENANCE.
5. INTERNAL ILLUMINATION TO BE WHITE LED.
6. RED/GREEN LIGHTS TO BE PUSH-THRU TRANSLUCENT WHITE ACRYLIC AND INTERNALLY ILLUMINATED WITH INDEPENDANTLY CONTROLLED RED AND GREEN LED LIGHTING. SURFACE OF PUSH-THRU LENS TO BE FLUSH WITH CABINET SURFACE. PROVIDE 3 SETTINGS PER LENS, RED, GREEN AND OFF.
7. PRIOR TO BID SUBMISSION, VERIFY FACILITY STRUCTURE PRIOR TO SIGNAGE FABRICATION. PROVIDE MOUNTING BRACKET AS REQUIRED BY STRUCTURAL ENGINEERING CALCULATIONS.
8. PRIOR TO BID SUBMISSION, COORDINATE STRUCTURAL, ELECTRICAL AND DATA REQUIREMENTS WITH GENERAL CONTRACTOR.
9. LAWA TO PROVIDE SPECIFIC MESSAGING PER SIGN LOCATION.

NOTE:

THE SCALE OF THE SIGNAGE AND GRAPHICS ARE SUBJECT TO CHANGE IN ORDER TO BE COMPLIANT WITH ADA GUIDELINES IF THE INSTALLATION SITE EXCEEDS THE HEIGHT SHOWN IN THE DRAWING PROVIDED.

ALL TEXT MUJST COMPLY WITH ADA STANDARDS INCLUDING TEXT HEIGHT, COLOR CONTRAST AND READABILITY FROM A DISTANCE AND ILLUMINATION.

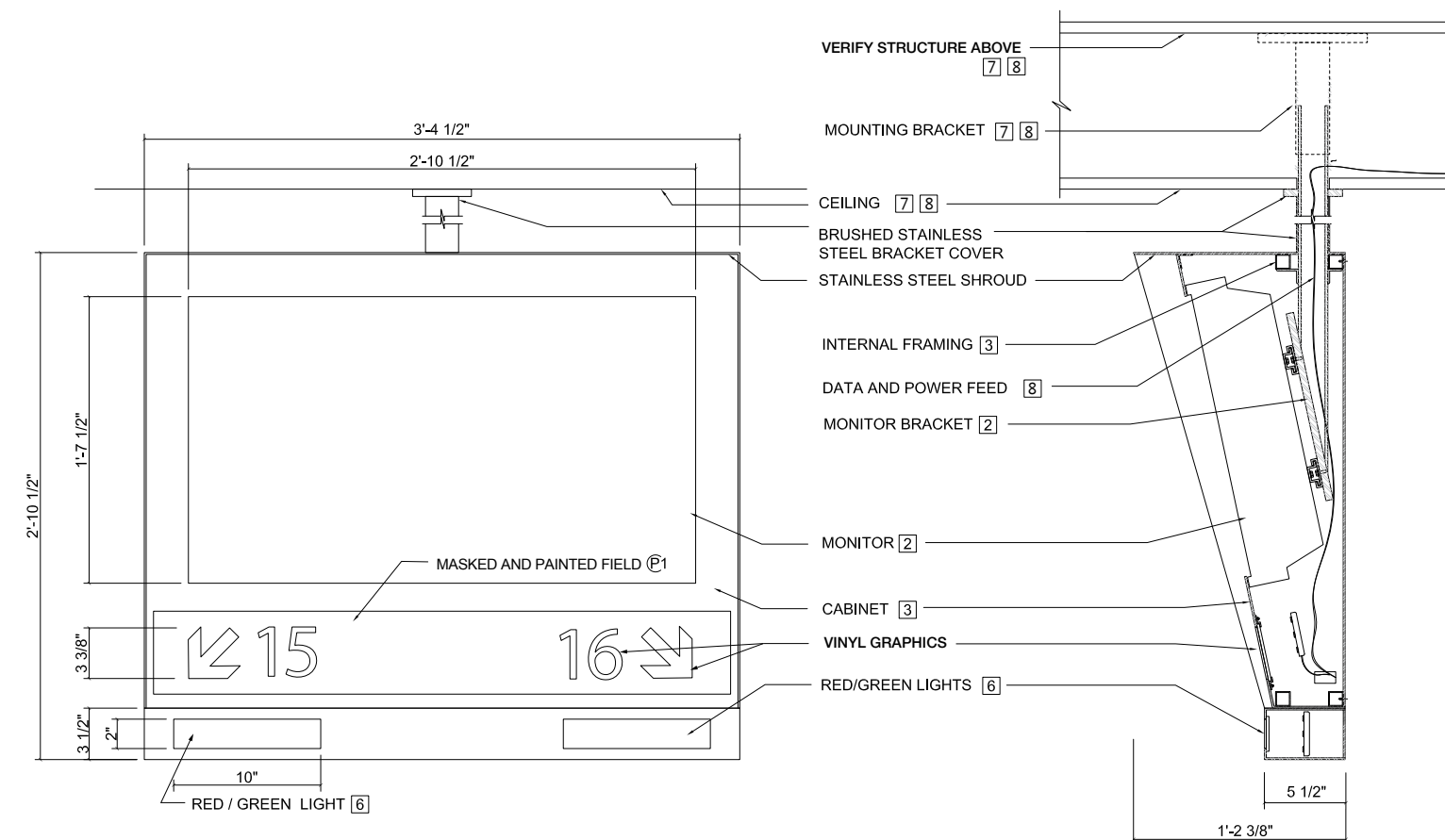

1 FRONT ELEVATION
SCALE: 1" = 1'-0"

2 SECTION
SCALE: 1" = 1'-0"

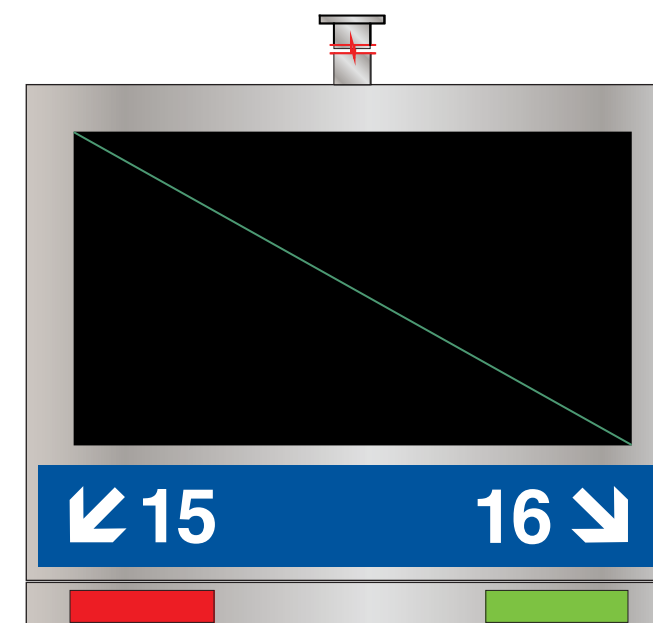

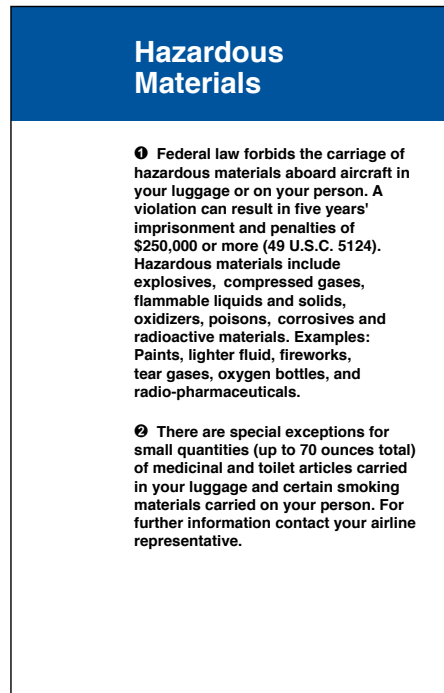

GENERAL NOTES:

- 1 1/8" THICK WHITE SINTRA PANEL WITH SCREENED GRAPHICS.
- 2 MOUNT TO WALL WITH SILICONE ADHESIVE AND DOUBLE-SIDED TAPE.
- 3 SIGNAGE SHOWN IS FOR PLACEMENT PURPOSES ONLY. OBTAIN MESSAGE AND SIGNAGE CRITERIA FROM LAWA.

NOTE:

ALL TEXT MUST COMPLY WITH THE ADA STANDARDS, INCLUDING FONT SIZE, COLOR CONTRAST AND READABILITY.

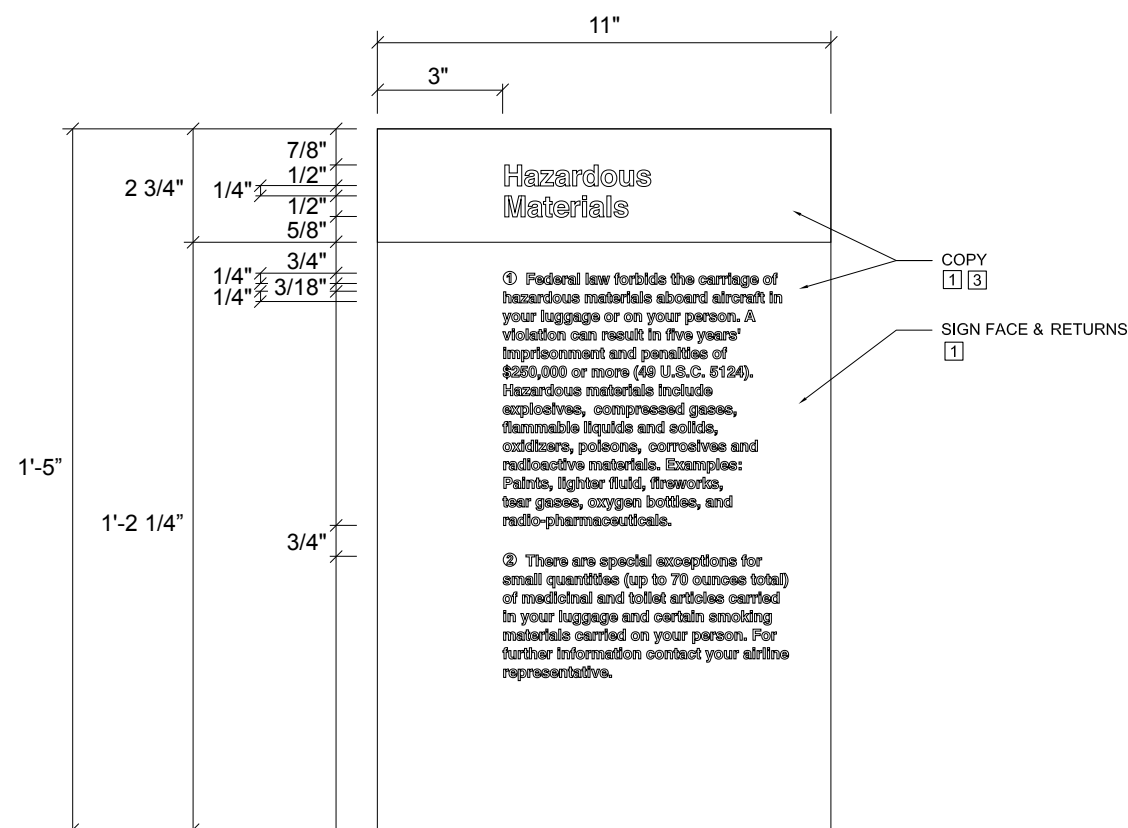

1 FRONT ELEVATION
NOT TO SCALE

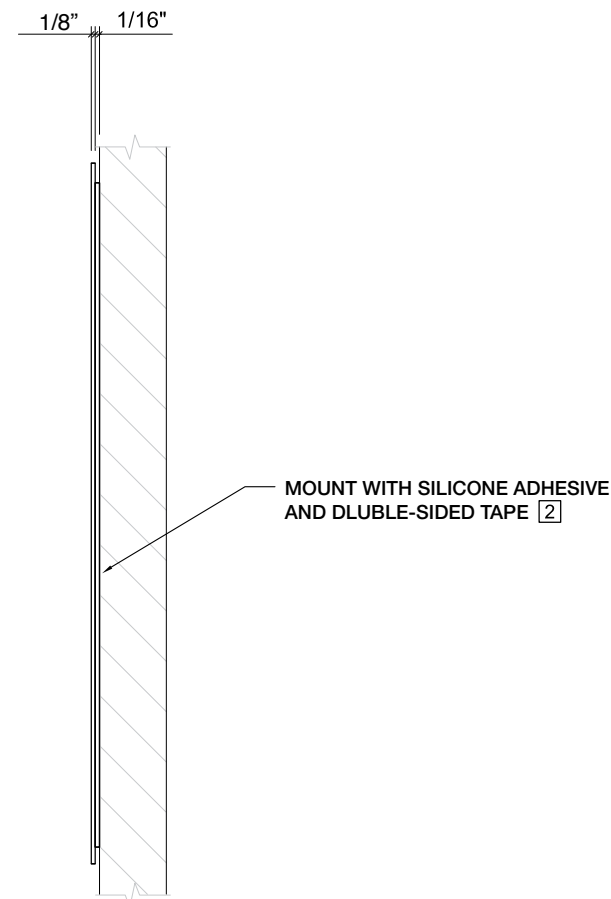

2 SIDE ELEVATION
NOT TO SCALE

Sign Type Design

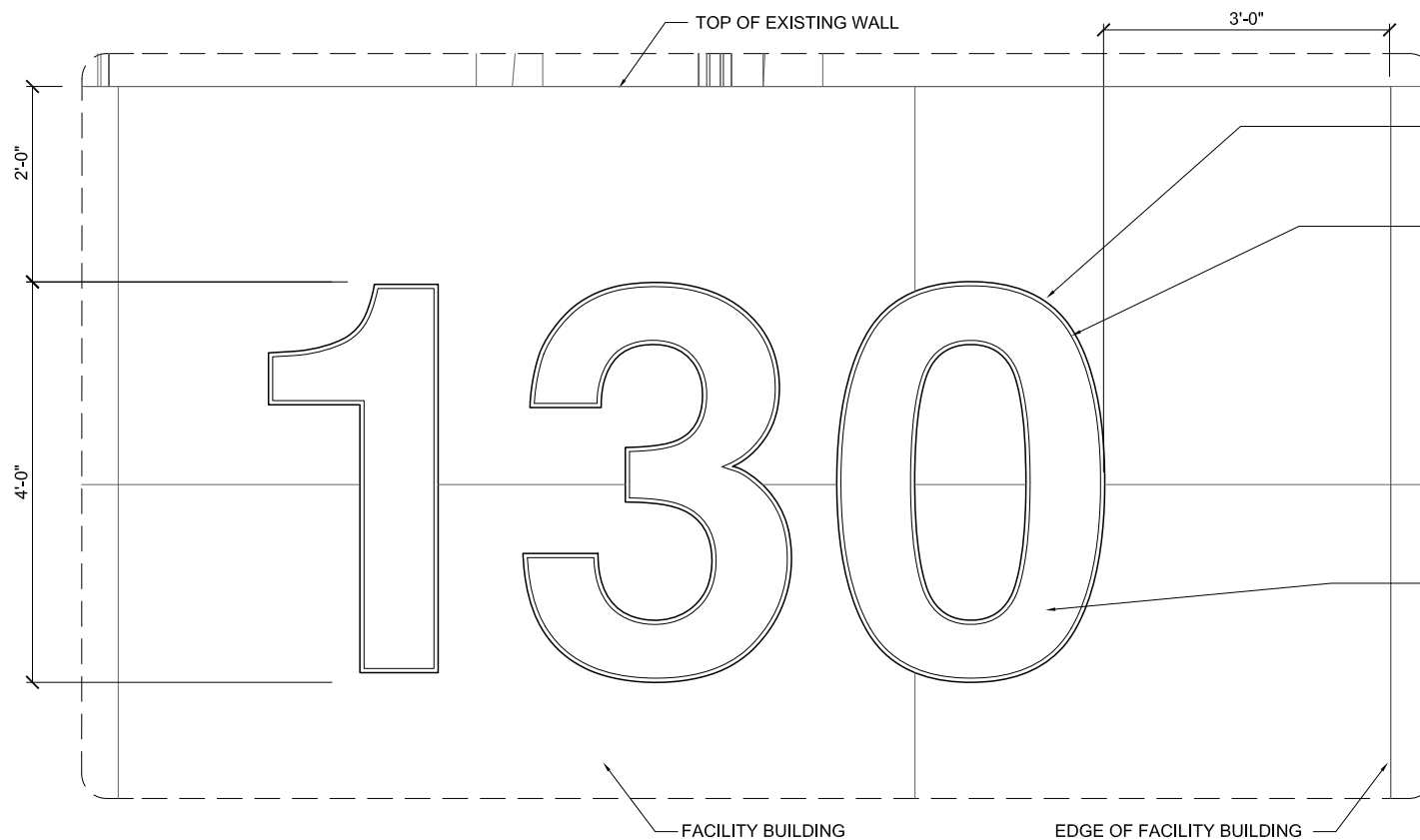
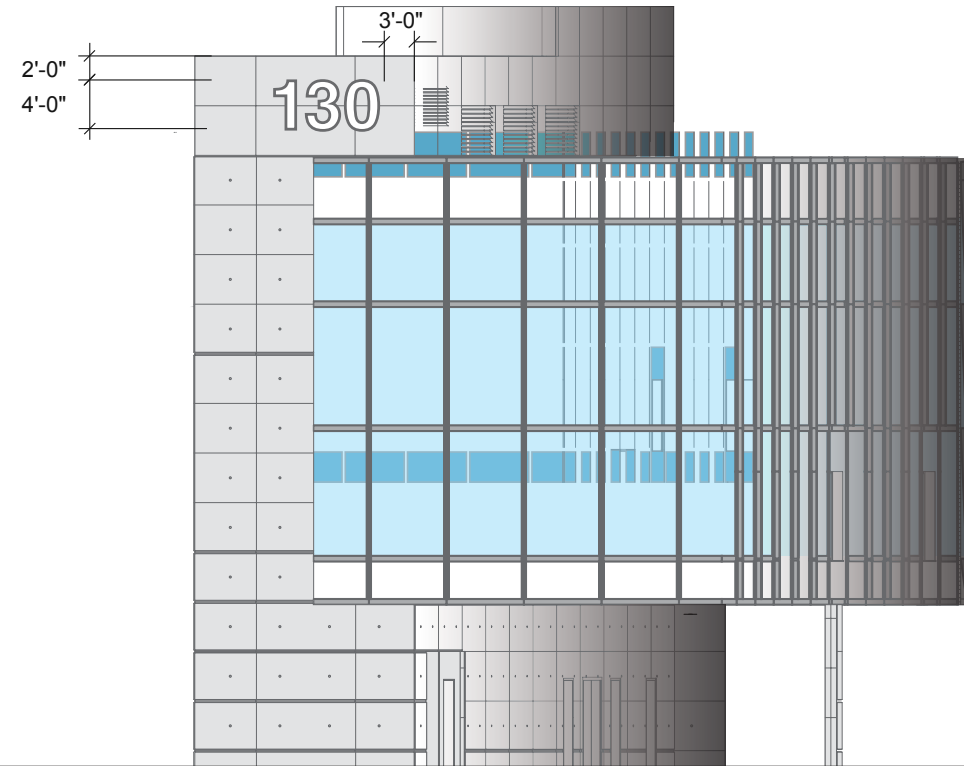

1 SECTION DETAIL
NOT TO SCALE

GENERAL NOTES:

1. FABRICATED CHANNEL NUMERALS WITH BRUSHED STAINLESS STEEL RETAINERS AND INTERNAL ILLUMINATION.
2. CHANNEL NUMERALS TO BE FABRICATED STAINLESS STEEL WITH BRUSHED FINISH RETURNS AND RETAINERS. RETURNS AND RETAINER TO BE WELDED WITH SEAMS FILLED AND FINISHED SMOOTH. NUMERALS TO BE FABRICATED IN A MANNER TO ALLOW EASE OF MAINTENANCE AND BE WEATHER-PROOF. PROVIDE WEEP HOLES WITH LIGHT BLOCKING "HATS".
3. NUMERAL FACES TO BE TRANSLUCENT WHITE POLYCARBONATE AND RETAINED IN A MANNER TO BE WEATHER-PROOF.
4. INTERNAL ILLUMINATION TO BE WHITE LED AS REQUIRED FOR EVEN ILLUMINATION.
5. COORDINATE WITH GENERAL CONTRACTOR FOR LOCATION AND REQUIREMENTS OF ELECTRICAL STUB-OUT AND WALL ANCHORS. ANCHORS AND ELECTRICAL STUB-OUT TO BE INSTALLED BY GENERAL CONTRACTOR. PROVIDE FULL-SIZED TEMPLATES PER LOCATION FOR ANCHOR AND STUB-OUT POSITIONS.
6. LETTERS TO BE MOUNTED FLUSH TO WALL.
7. ESTIMATED SIGN WEIGHT: 300LBS. 120V CIRCUIT WITH MINIMUM 1000 WATTS REQUIRED FOR EACH LOCATION
8. REFER TO LAWA FOR EXACT MESSAGE PER LOCATION OF SIGN.
9. ISOLATE DISSIMILAR METALS AS REQUIRED.

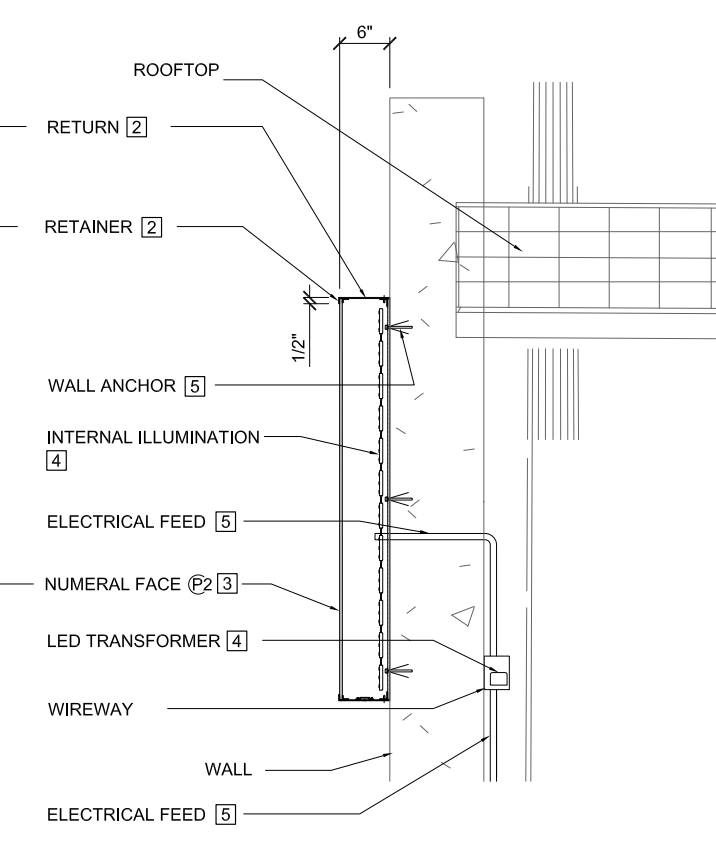

2 SECTION DETAIL
NOT TO SCALE

South Concourse

Gates 150-159

GENERAL NOTES:

1. NON-ILLUMINATED, DIMENSIONAL LETTERING MOUNTED TO WALL.
2. FABRICATED ALUMINUM LETTERS WITH PAINTED FINISH.
3. MESSAGE, SIZE, AND LOCATION TO BE DETERMINED BY LAWA.
4. FONT: HELVETICA NEUE LT PRO 85 HEAVY

South Concourse

Gates 150-159

1 FRONT ELEVATION
NOT TO SCALE

Sign Type Design

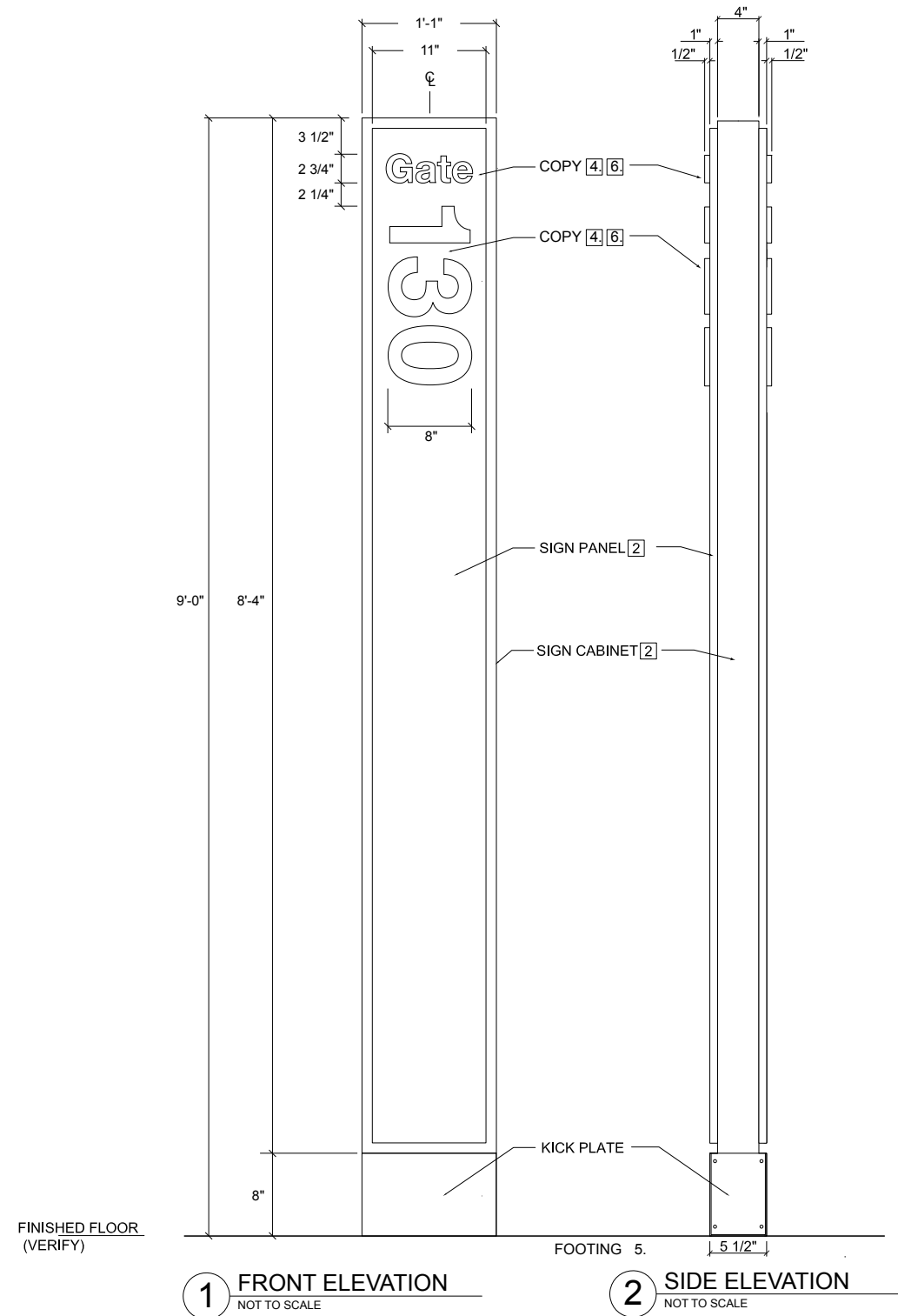

GENERAL NOTES:

1. DOUBLE-FACED, NON ILLUMINATED, FREESTANDING PYLON SIGN WITH DIMENSIONAL COPY.
2. FABRICATED ALUMINUM CABINET WITH INTERNAL STRUCTURE AS REQUIRED.
3. SIGN PANELS TO BE FABRICATED ALUMINUM PAINTED IN COLOR INDICATED. ATTACH TO SIGN CABINET IN AN INCONSPICUOUS MANNER.
4. COPY TO BE FLAT-CUT-OUT PAINTED ALUMINUM FLUSH MOUNTED TO SIGN PANEL WITH HIDDEN MECHANICAL FASTENERS. FACE AND EDGES OF COPY TO BE PAINTED IN COLOR INDICATED.
5. DESIGNER TO FIELD VERIFY AND DETERMINE BEST METHOD OF INSTALLATION. DESIGNER TO PROVIDE STRUCTURAL ENGINEERING CALCULATIONS AS REQUIRED AND COORDINATE WITH GENERAL CONTRACTOR FOR FOOTING REQUIREMENTS.
6. LAWA TO PROVIDE SPECIFIC MESSAGES PER SIGN LOCATION.

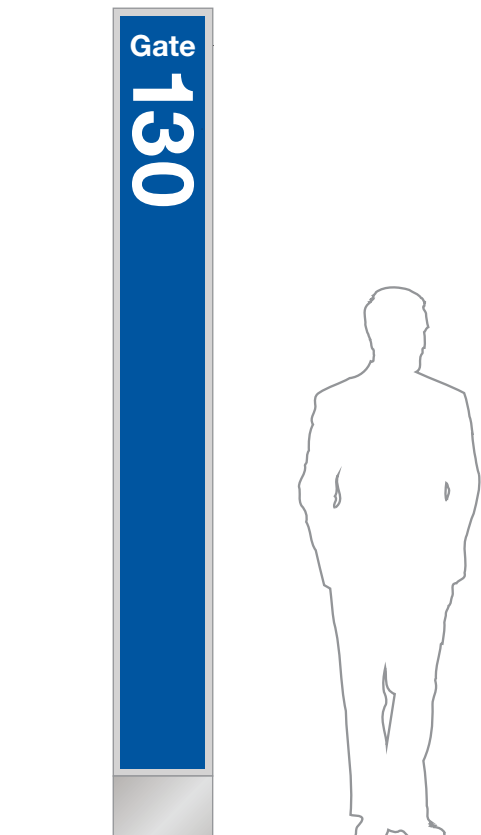

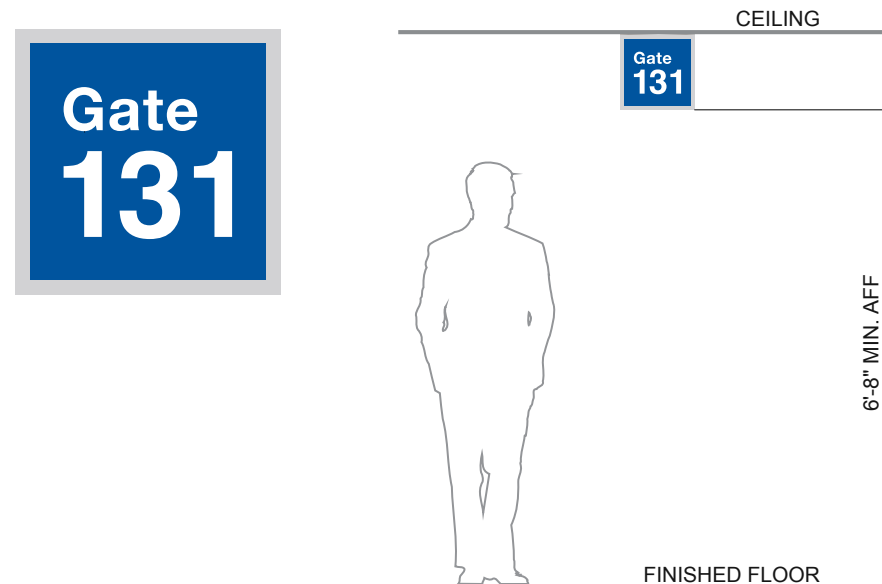

GENERAL NOTES:

1. NON-ILLUMINATED SIGN PANEL WITH MOUNTING BRACKET.
2. BACKGROUND PANEL TO BE 1/2" ALUMINUM INTEGRATED WITH MOUNTING BRACKET AS REQUIRED.
3. SIGN PANEL TO BE 1/8" THICK PAINTED ALUMINUM PANEL IN COLOR INDICATED. ATTACH TO BACKGROUND PANEL IN A PERMANENT MANNER.
4. GRAPHICS TO BE 1/4" THICK FLAT CUT OUT PAINTED ALUMINUM ADHERED TO SIGN PANEL WITH EPOXY AND ALIGNMENT PINS OR HIDDEN FASTENERS.
5. ALUMINUM MOUNTING BRACKET WITH WELDED CONSTRUCTION AS REQUIRED. ATTACH TO CEILING WITH FLAT-HEAD/COUNTERSUNK FASTENERS AS REQUIRED.
6. FIELD VERIFY EXISTING CONDITIONS PRIOR TO FABRICATION OF SIGNS. COORDINATE WITH G.C. AND DETERMINE BEST METHOD FOR INSTALLATION REQUIREMENTS.
7. LAWA TO PROVIDE SIGN LOCATIONS AND SPECIFIC MESSAGE PER SIGN LOCATION.
8. A MINIMUM VERTICAL CLEARANCE OF 6'-8" AFF ON ELEVATION.

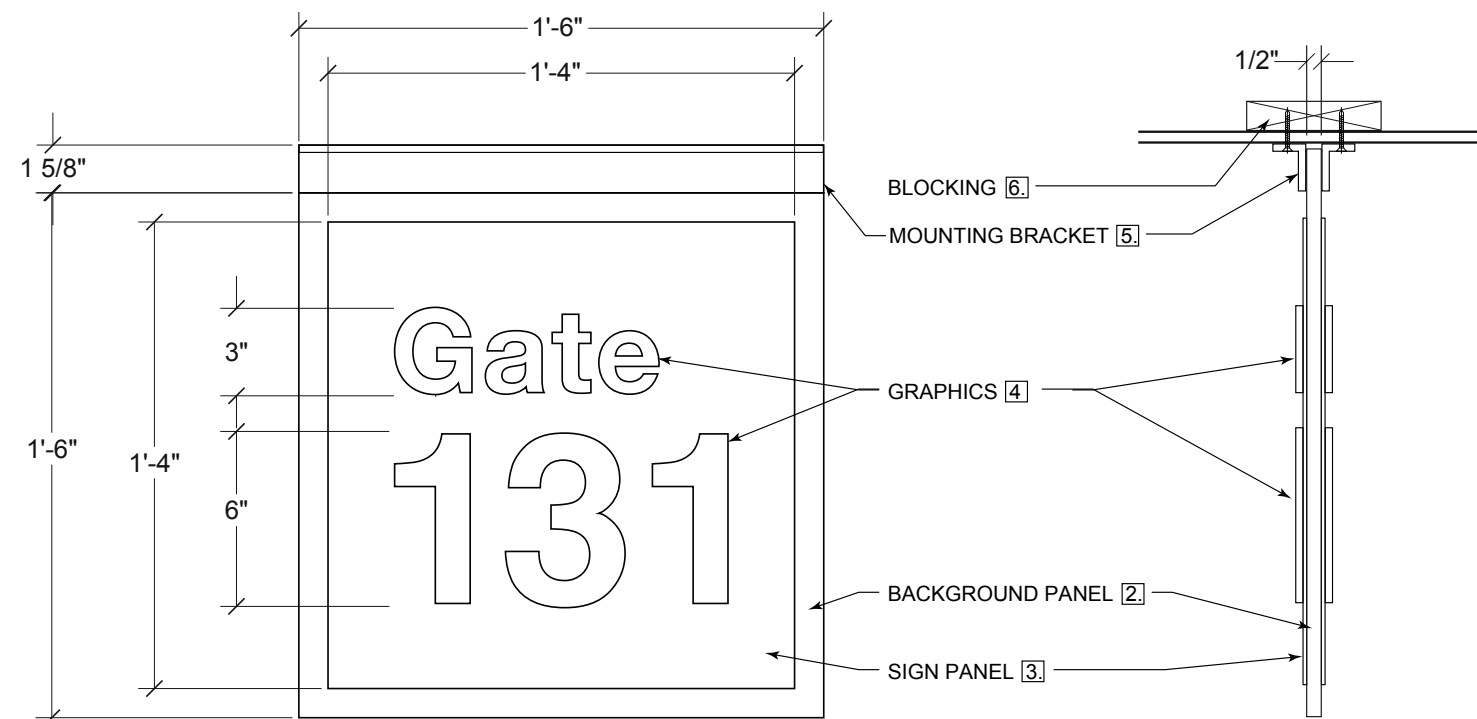

1 FRONT ELEVATION
NOT TO SCALE

2 SIDE ELEVATION
NOT TO SCALE

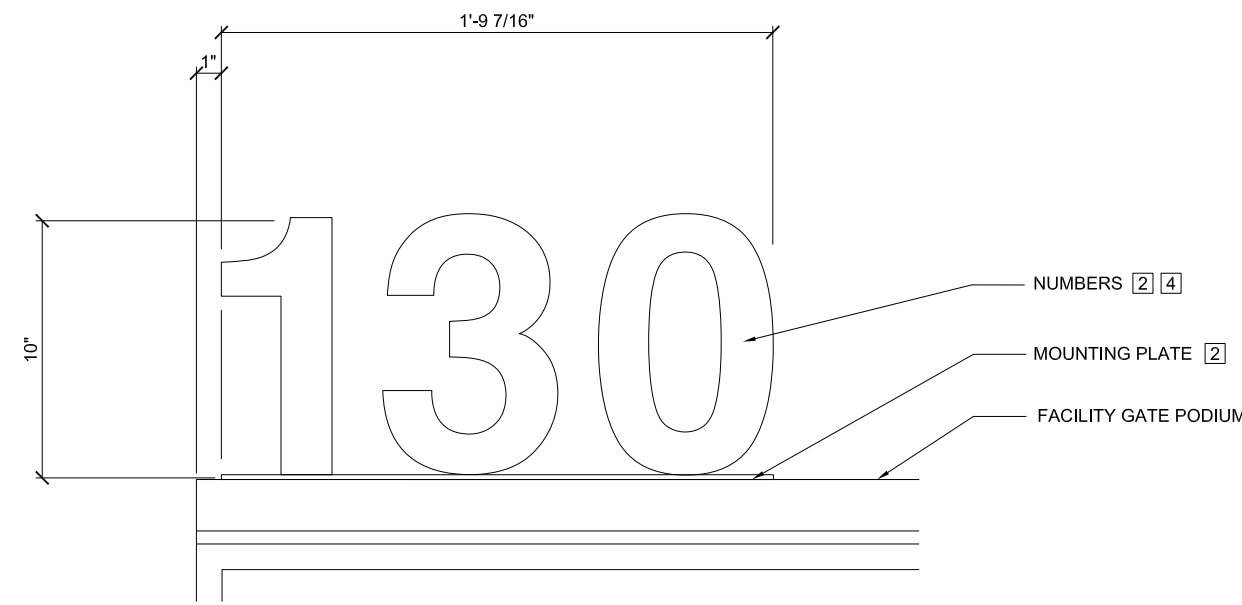
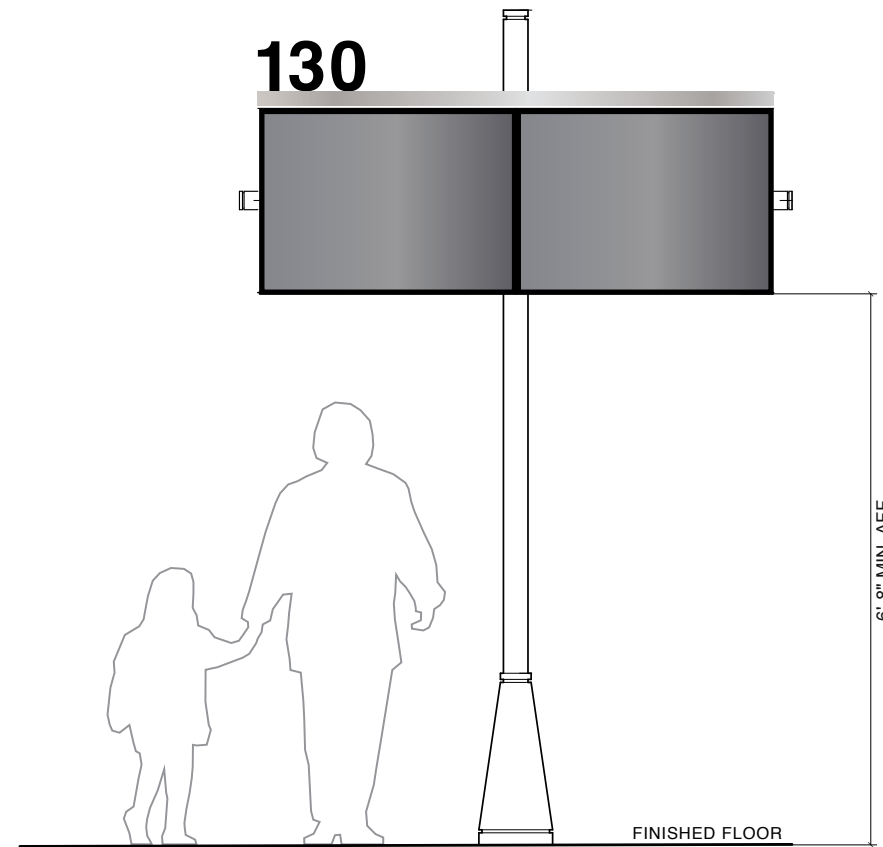

1 FRONT ELEVATION
SCALE: 1 1/2" = 1'-0"

GENERAL NOTES:

- [1] FABRICATED ALUMINUM NUMBERS.
- [2] NUMBERS TO BE FABRICATED ALUMIUM WITH ALL SURFACES PAINTED IN COLOR NOTED. NUMBERS TO BE MOUNTED TO 3/16" THICK ALUMINUM BASE PLATE.
- [3] ATTACH SIGNAGE TO FACILITY GATE PODIUM WITH COUNTERSUNK MECHANICAL FASTENERS AS REQUIRED.
- [4] FIELD VERIFY EXISTING CONDITIONS. COORDINATE WITH GENERAL CONTRACTOR TO DETERMINE BEST METHOD OF INSTALLATION BASED ON STRUCTURAL ENGINEERING CALCULATIONS.
- [5] LAWA TO PROVIDE LOCATIONS AND SPECIFIC MESSAGES PER SIGN LOCATION.
- [6] A MINIMUM VERTICAL CLEARANCE OF 6'-8" AFF ON ELEVATION.

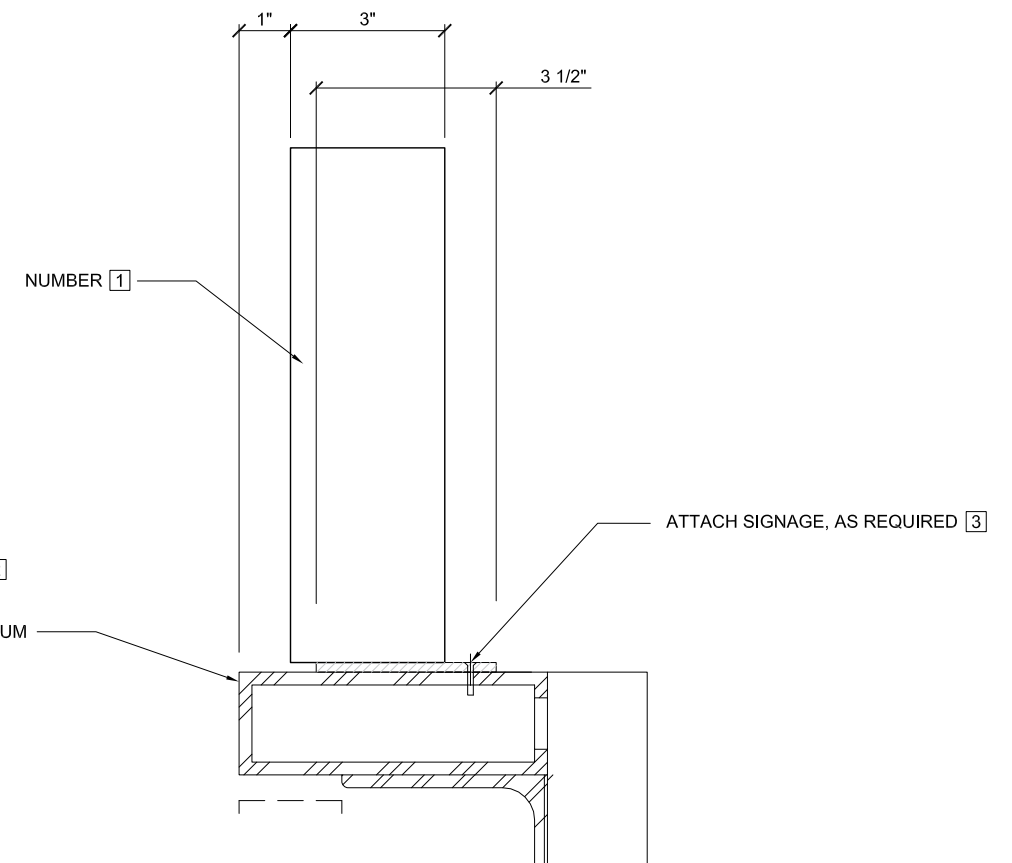

2 SECTION DETAIL
SCALE: 3" = 1'-0"

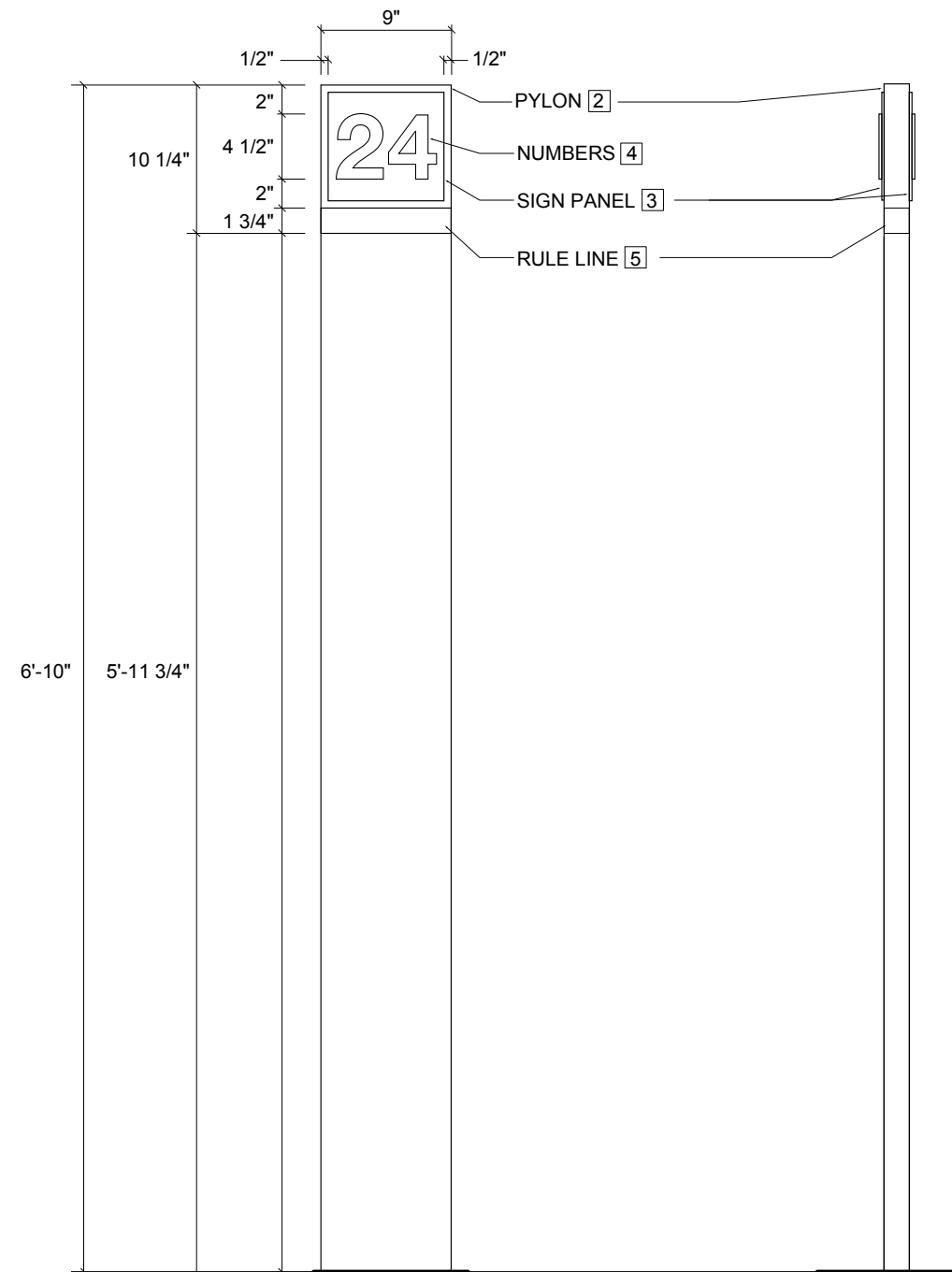

1 FRONT ELEVATION
NOT TO SCALE

- GENERAL NOTES:
1. FREESTANDING, NON-ILLUMINATED, DOUBLE-FACED FABRICATED PYLON IDENTITY.
 2. PYLON TO BE FABRICATED ALUMINUM CONSTRUCTION WITH BRUSHED FINISH.
 3. SIGN PANEL TO BE 1/8" THICK PAINTED ALUMINUM PANEL PERMANENTLY ADHERED TO PYLON.
 4. NUMBER TO BE FLAT-CUT-OUT 22 GAUGE ALUMINUM WITH FACE AND EDGES PAINTED IN COLOR NOTED.
 5. RULE LINE TO BE MASKED AND SPRAY PAINTED OR SCREEN PRINTED.
 6. FIELD VERIFY EXISTING CONDITIONS. COORDINATE WITH GENERAL CONTRACTOR TO DETERMINE BEST METHOD OF INSTALLATION BASED ON STRUCTURAL ENGINEERING CALCULATIONS.
 7. LAWYER TO PROVIDE LOCATIONS AND SPECIFIC MESSAGES PER SIGN LOCATION.
 8. LAWYER TO PROVIDE OVERALL SIGNAGE DIMENSIONS.

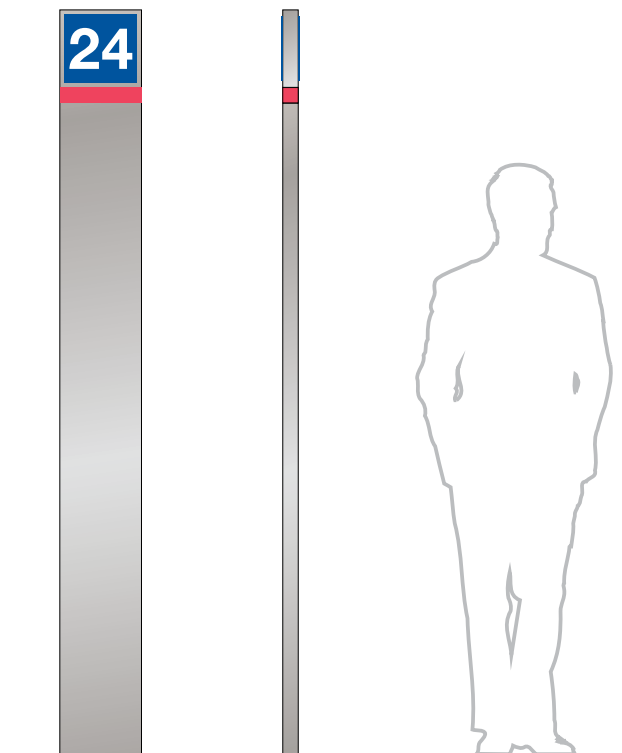

Sign Type Design

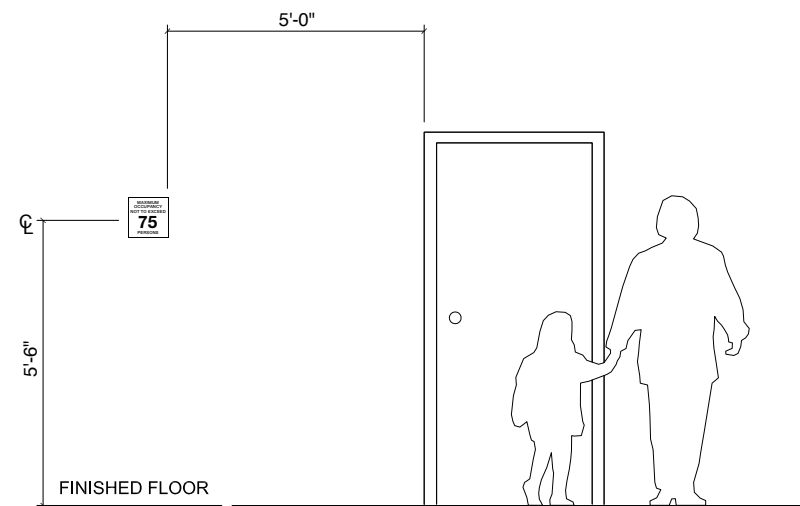

3 CONTEXT ELEVATION
NOT TO SCALE

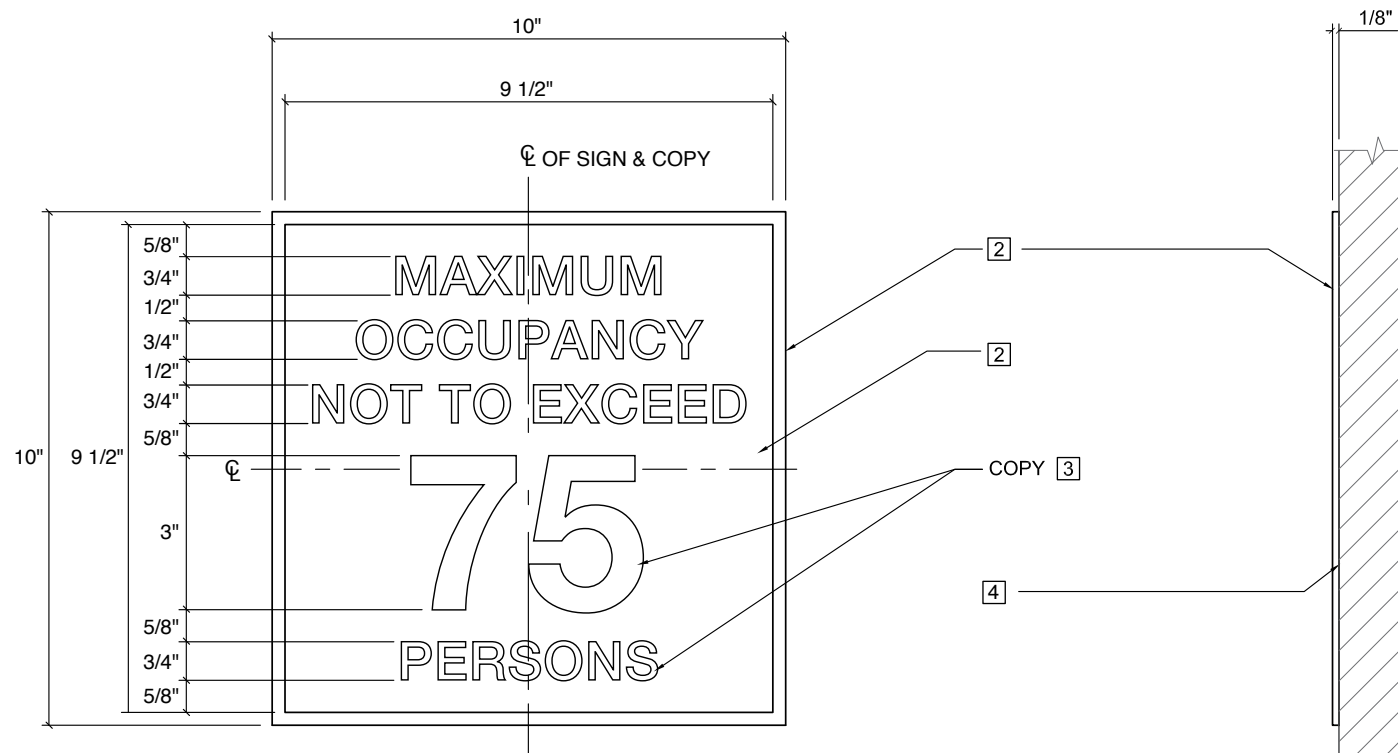

1 FRONT ELEVATION
NOT TO SCALE

2 SIDE ELEVATION
NOT TO SCALE

GENERAL NOTES:

- 1 WALL MOUNTED PLAQUE WITH PAINTED BACKGROUND AND SCREENED GRAPHICS.
- 2 SIGN PANEL TO BE 1/8" THICK BRUSHED ALUMINUM WITH MASKED AND PAINTED BACKGROUND.
- 3 COPY TO BE 3M MATTE WHITE OPAQUE FILM MACHINE CUT VINYL AS INDICATED ON DRAWING.
- 4 FLUSH MOUNT ONTO EXISTING INTERIOR WALL WITH SILICONE ADHESIVE AND VHB TAPE AS REQUIRED.
- 5 LAWA TO PROVIDE SPECIFIC MESSAGE PER LOCATION OF SIGN.



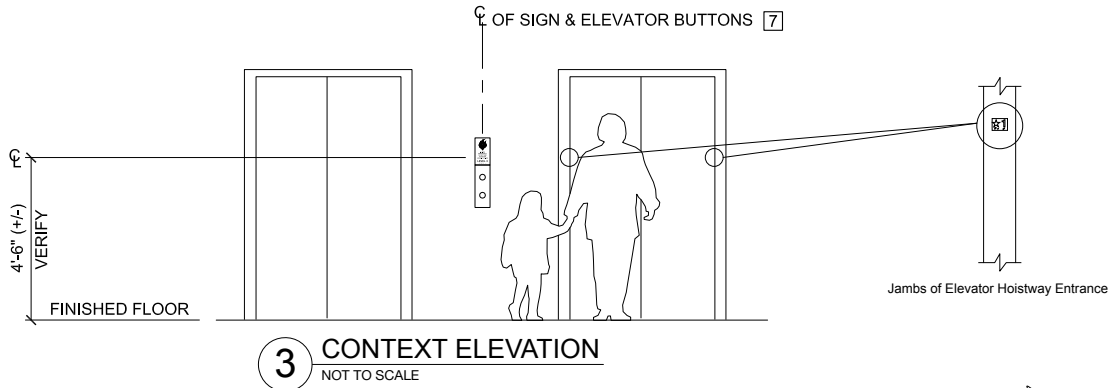

GENERAL NOTES:

- [1] 1/8" THICK STAINLESS STEEL PANEL WITH SCREENPRINTED GRAPHICS.
- [2] INLAYED 1/32" D. DIMENSIONAL LETTERS TO BE 1/16" THICK PAINTED AS NOTED.
- [3] MOUNT TO WALL WITH SPACER PANEL (THICKNESS DETERMINED BY EXISTING CALL BUTTON PANEL), VHB TAPE AND SILICONE ADHESIVE.
- [4] BRAILLE TO BE GRADE 2 STAINLESS STEEL BEADS.
- [5] REFER TO MESSAGE SCHEDULE FOR EXACT MESSAGE PER LOCATION OF SIGN.
- [6] WIDTH IS DETERMINED BY WIDTH OF ELEVATOR CALL BUTTON PANEL. CONFIRM PRIOR TO FABRICATION OF SIGN.
- [7] FIELD VERIFY PRIOR TO FABRICATION.

NOTE:
THIS SIGN IS NOT REQUIRED, NOR SHOULD IT BE PROVIDED AT ELEVATORS THAT SERVE AS AN ACCESSIBLE MEANS OF EGRESS (CBC 3002.3, EXCEPTION 1), OR AT ELEVATORS THAT ARE USED FOR OCCUPANT SELF-EVACUATION IN ACCORDANCE WITH CBC 3008 (CBC 3002.3, EXCEPTION 2).

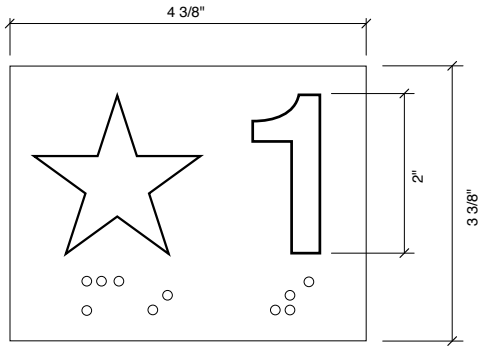
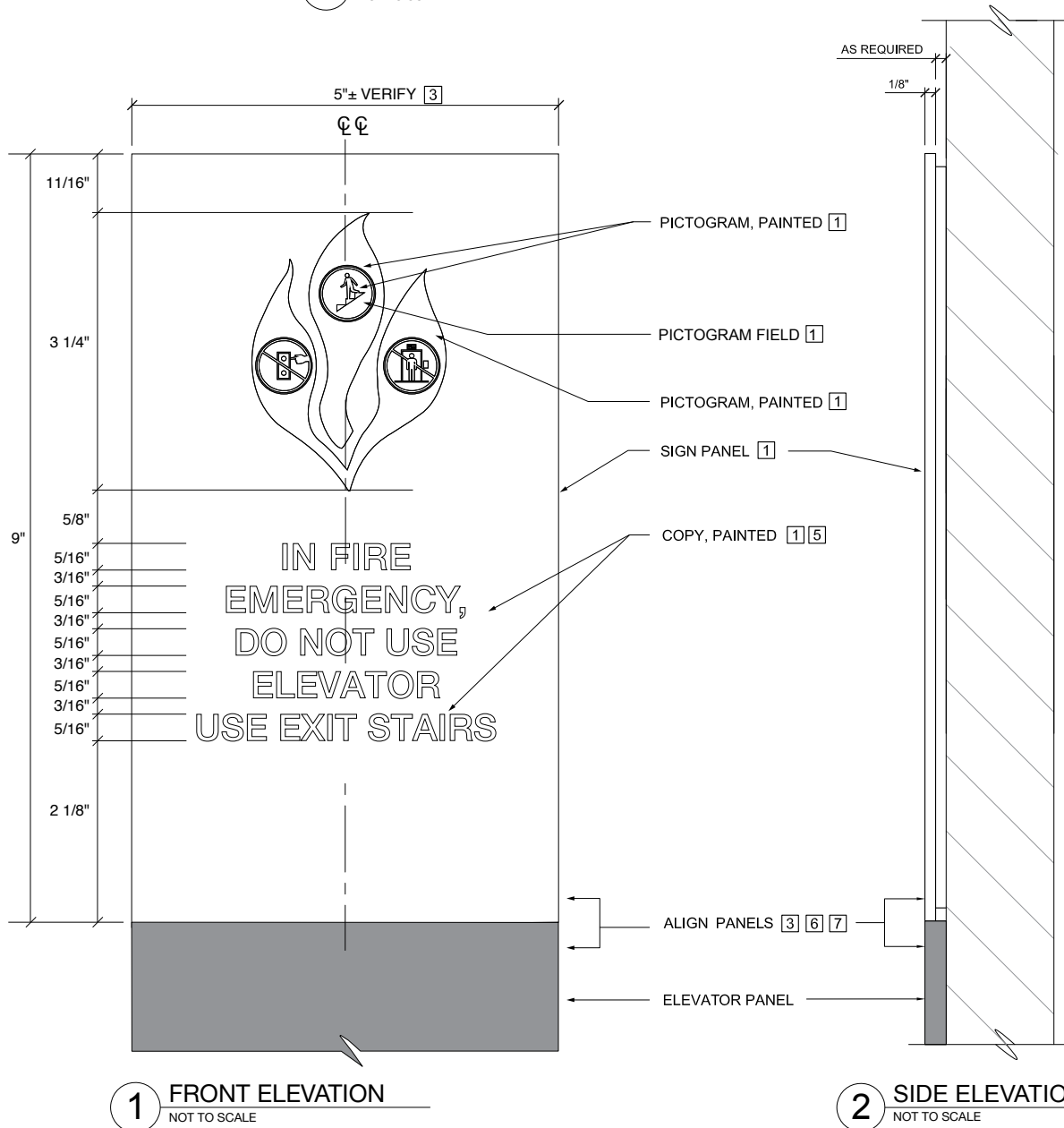

ELEVATOR HOISTWAY SIGN

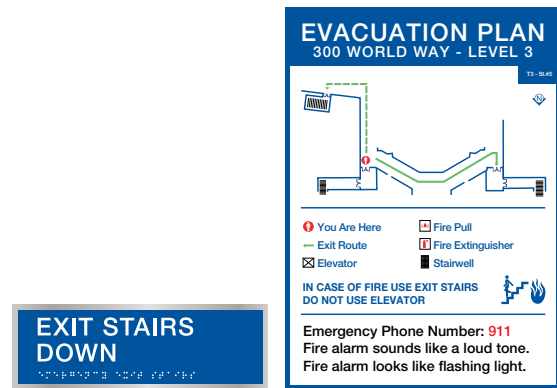

6 CONTEXT ELEVATION
NOT TO SCALE

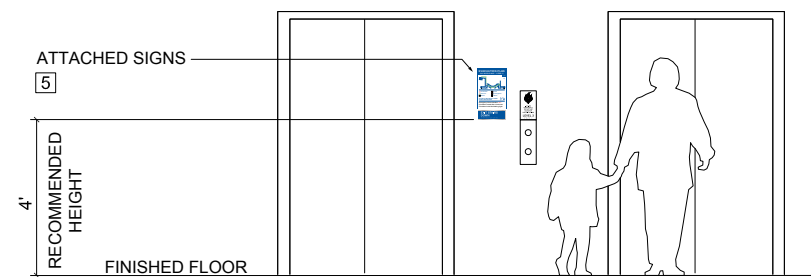

3 CONTEXT ELEVATION
NOT TO SCALE

GENERAL NOTES:

1. EVACUATION PLAN REGULATION SIGNAGE.
2. SIGN BACKGROUND TO BE 1/8" THICK ALUMINUM WITH BRUSHED FINISH ON FACE AND EDGES.
3. 1/8" THICK PAINTED ACRYLIC SIGN PANEL TO BE ADHERED TO SIGN BACKGROUND IN A PERMANENT MANNER.
4. ALL COPY AND GRAPHICS TO BE SCREEN PRINTED IN COLORS INDICATED.
5. FLUSH MOUNT TO EXISTING WALL WITH WELDED THREADED STUDS AND SILICONE ADHESIVE AS REQUIRED.
6. LAWA TO PROVIDE BASE MAP ART AND SPECIFIC MESSAGES PER LOCATION OF SIGN.

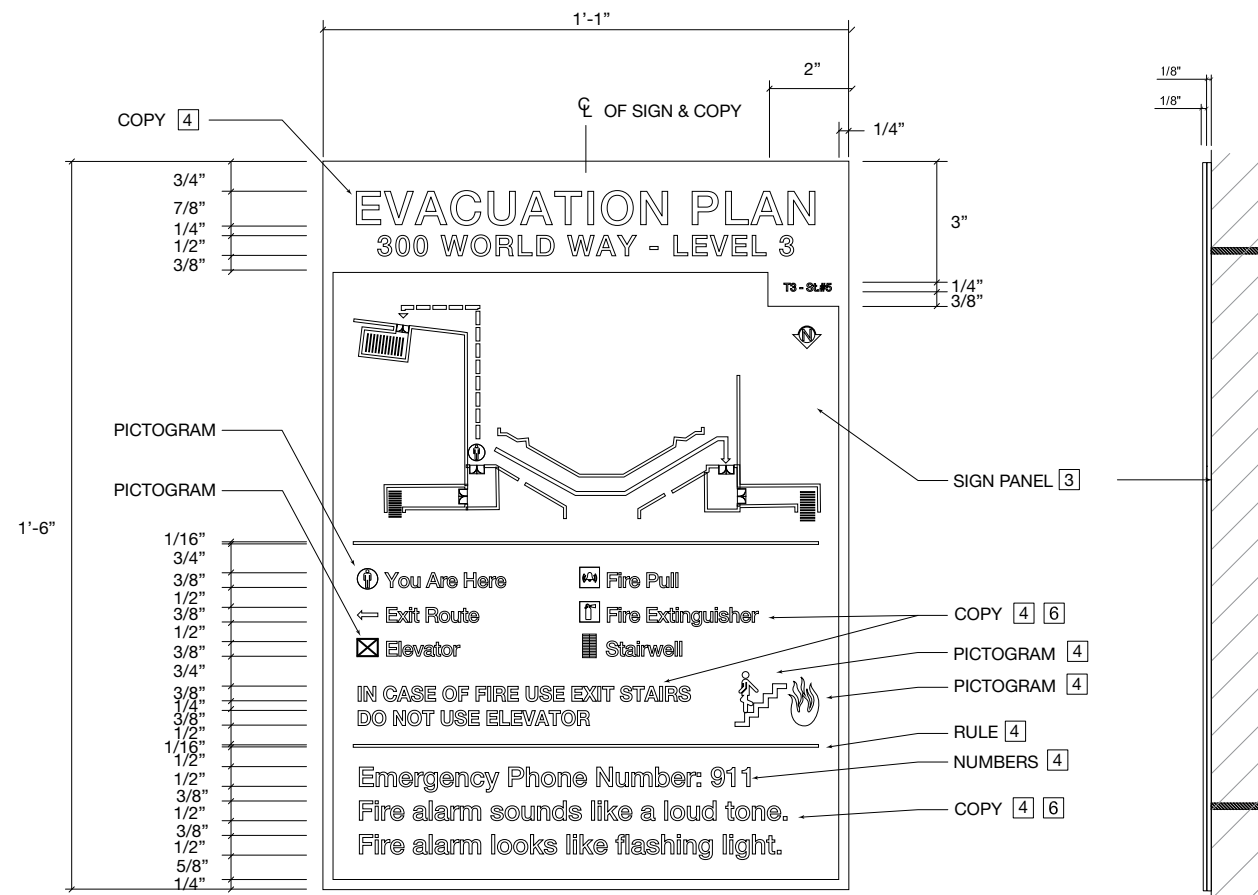

1 FRONT ELEVATION - ALT 1
NOT TO SCALE



2 SIDE ELEVATION
NOT TO SCALE

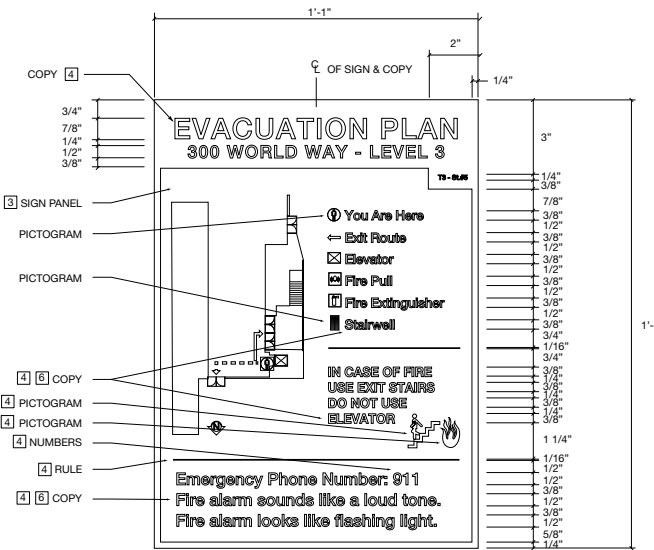

5 FRONT ELEVATION - ALT 2
NOT TO SCALE

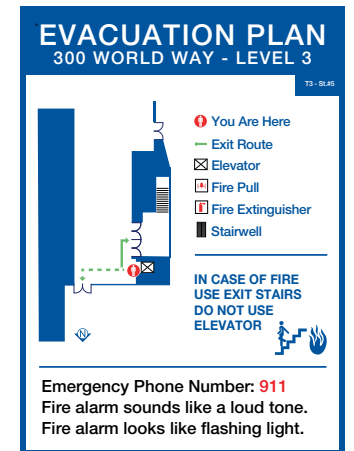

4 SIDE ELEVATION
NOT TO SCALE

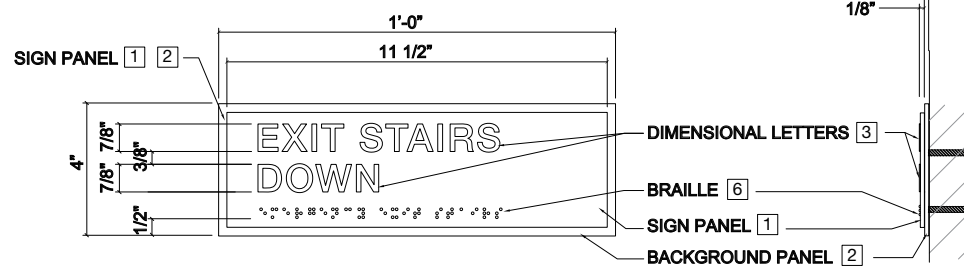

3 FRONT ELEVATION
NOT TO SCALE

GENERAL NOTES:

- 1 WALL MOUNTED PLAQUE WITH PAINTED BACKGROUND AND SCREENED GRAPHICS.
- 2 SIGN PANEL TO BE 1/8" THICK BRUSHED ALUMINUM WITH MASKED AND PAINTED BACKGROUND.
- 3 COPY AND GRAPHICS TO BE MACHINE CUT VINYL ON INDIVIDUAL CHANGEABLE PANELS WITH COLOR TO MATCH AS INDICATED ON DRAWING.
- 4 FLUSH MOUNT ONTO EXISTING INTERIOR WALL WITH SILICONE ADHESIVE AND VHB TAPE AS REQUIRED.
- 5 LAWMA TO PROVIDE SPECIFIC MESSAGE PER LOCATION OF SIGN.

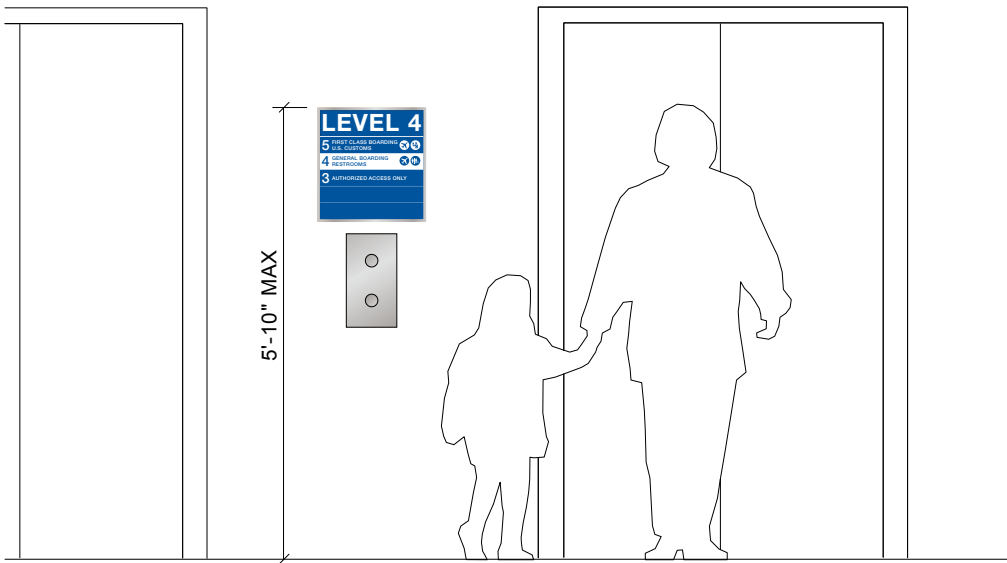
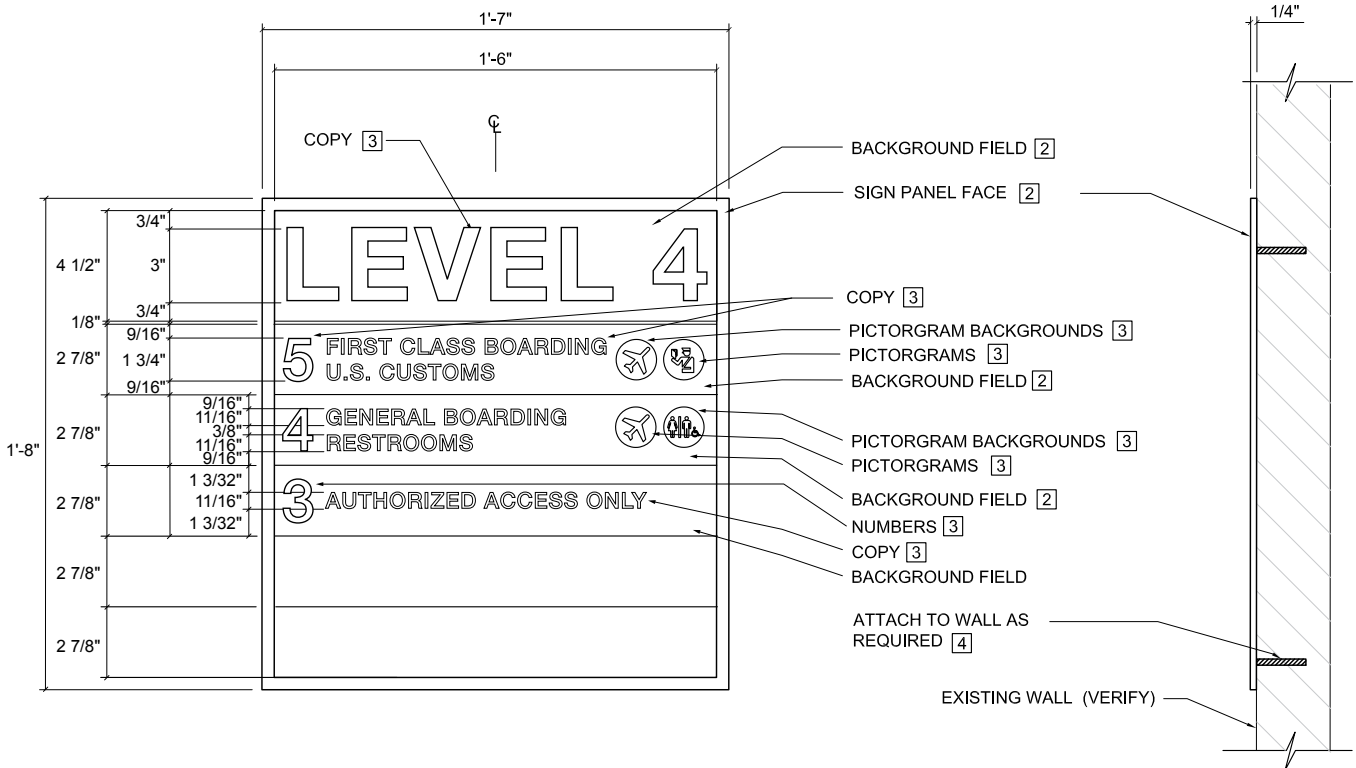

Sign Type Design

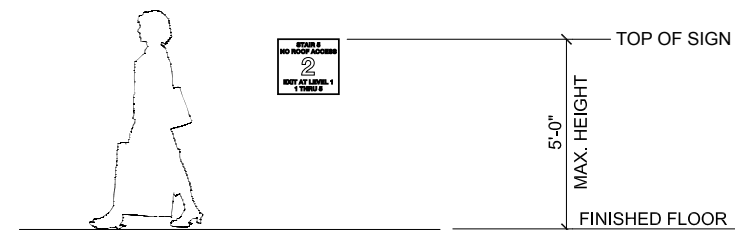

4 CONTEXT ELEVATION
SCALE: 3/16" = 1'-0"

GENERAL NOTES:

1. ADA AND LOCAL FIRE CODE COMPLIANT WALL MOUNTED IDENTIFICATION PANEL.
2. BACKGROUND PANEL TO BE 4MM SINTRA FINISH ON FACE AND EDGES.
3. SIGN PANEL TO BE 1/8" THICK PHOTOPOLYMER PANEL.
4. FLUSH MOUNT ONTO EXISTING INTERIOR WALL WITH SILICONE ADHESIVE AND VHB TAPE AS REQUIRED.
5. VERIFY WITH LAWA FOR SPECIFIC MESSAGES PER SIGN LOCATION.

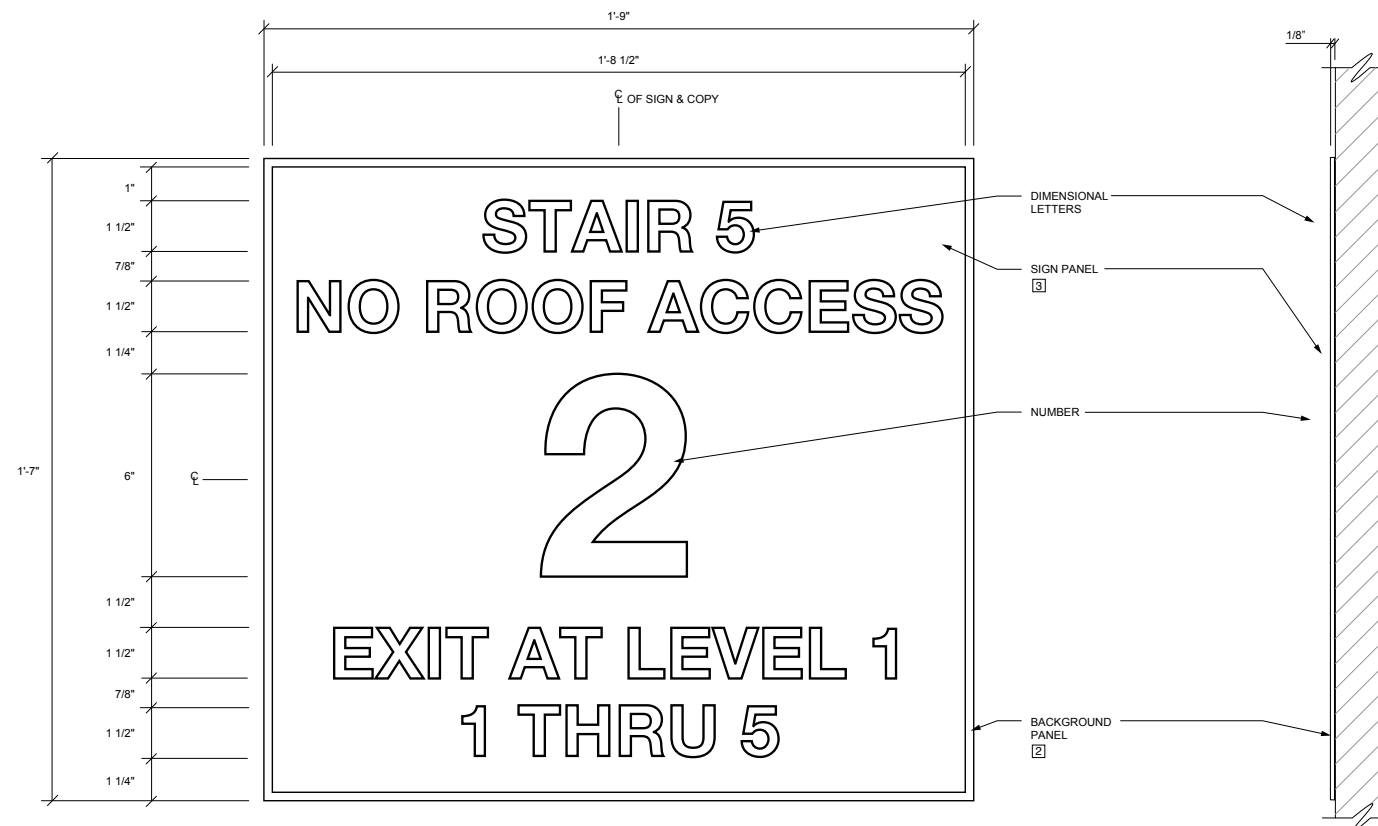

1 FRONT ELEVATION
NOT TO SCALE

2 SIDE ELEVATION
NOT TO SCALE



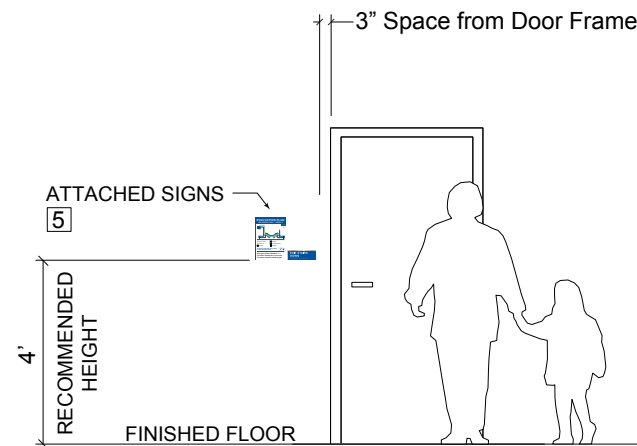
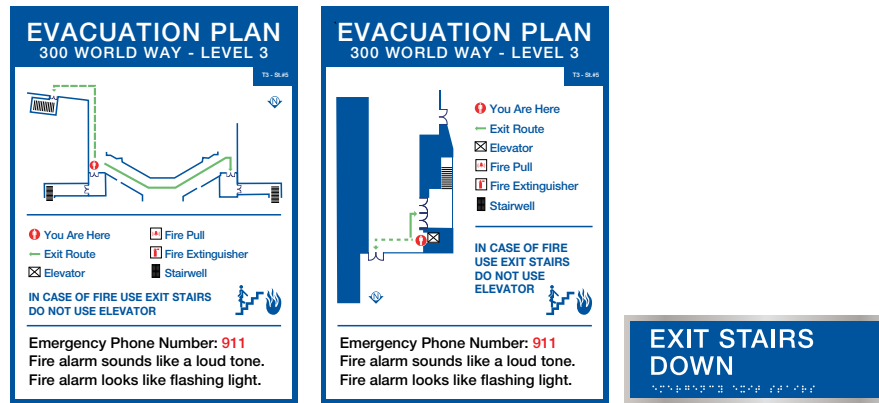

GENERAL NOTES:

- EVACUATION PLAN REGULATION SIGNAGE.
- SIGN BACKGROUND TO BE 1/8" THICK ALUMINUM WITH BRUSHED FINISH ON FACE AND EDGES.
- 1/8" THICK PAINTED ACRYLIC SIGN PANEL TO BE ADHERED TO SIGN BACKGROUND IN A PERMANENT MANNER.
- ALL COPY AND GRAPHICS TO BE SCREEN PRINTED IN COLORS INDICATED AS SHOWN ON 3.
- FLUSH MOUNT TO EXISTING WALL WITH WELDED THREADED STUDS AND SILICONE ADHESIVE AS REQUIRED. CLEAR PHOTOPOLYMER WITH REVERSE PRINTED BACKGROUND COLOR. TACTILE SIGN SHOULD BE MOUNTED CLOSEST TO THE DOOR. THE CENTER OF THE SIGN SHOULD BE 9" TO THE CENTER OF THE DOOR FRAME AND PLACED WITHIN AN 18" FIELD.
- LAWA TO PROVIDE BASE MAP ART AND SPECIFIC MESSAGES PER LOCATION OF SIGN.

NOTE:

SEE PAGE 51 FOR A REDUCE SIZE EVACUATION PLAN, ONLY IF WALL AREA DOES NOT FIT THE SIZE OF THESE SIGNS.

6 CONTEXT ELEVATION
NOT TO SCALE

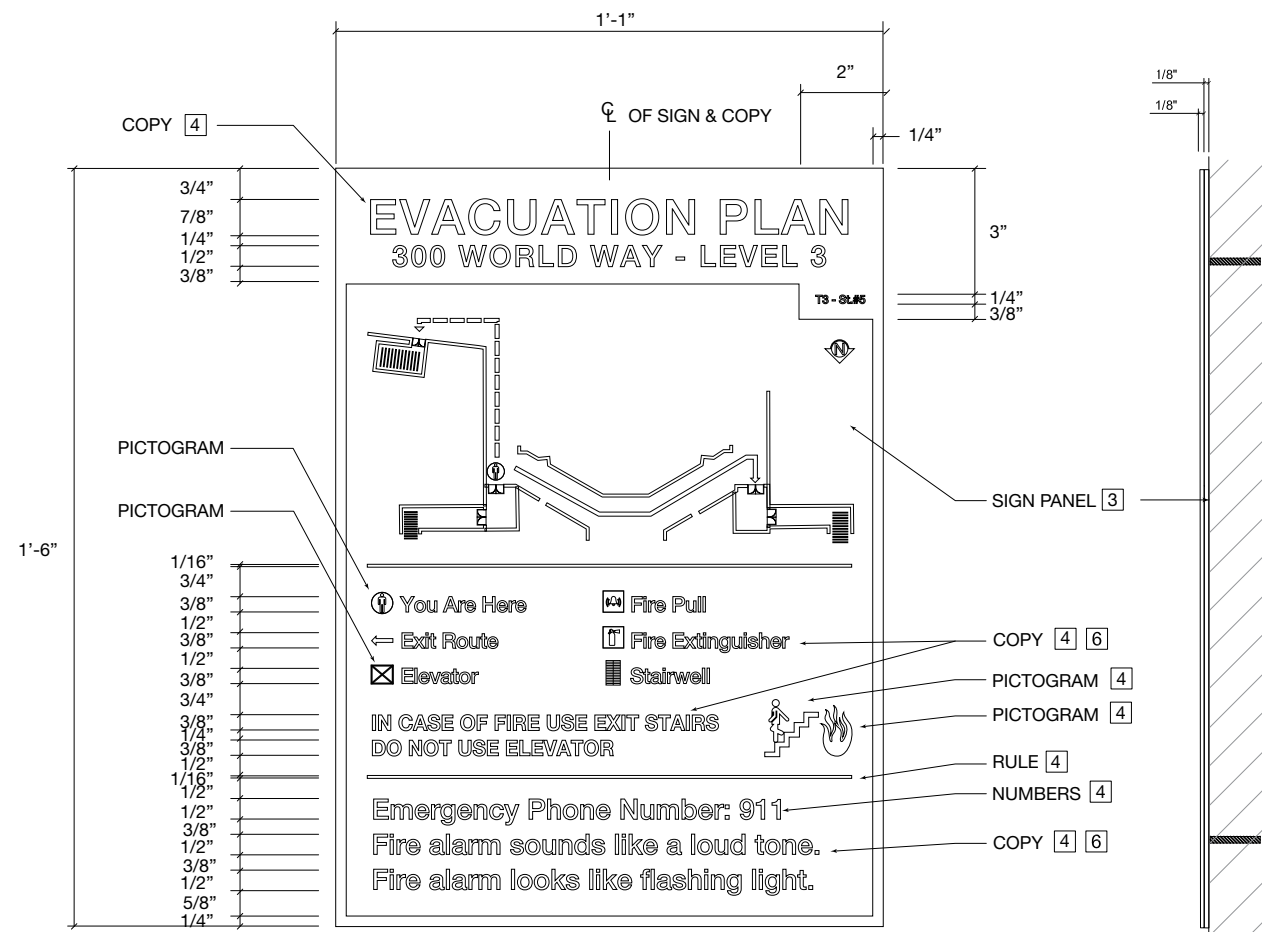

1 FRONT ELEVATION - ALT 1
NOT TO SCALE

2 SIDE ELEVATION
NOT TO SCALE

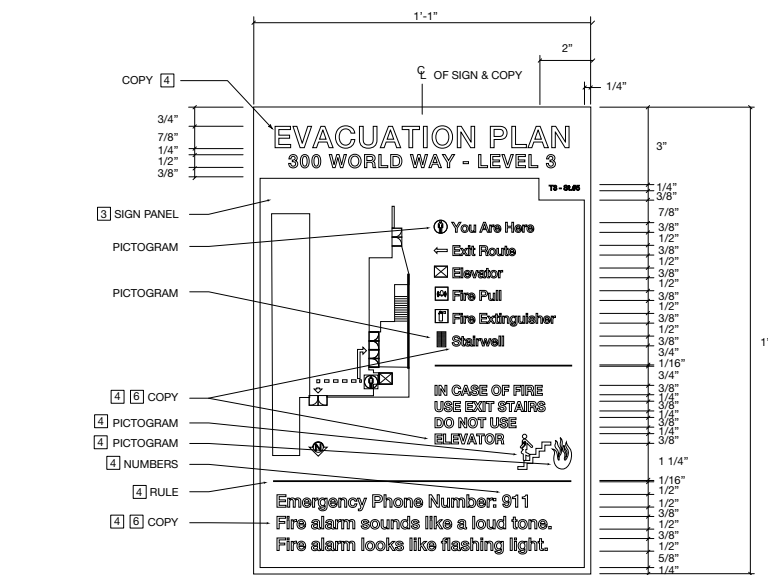

5 FRONT ELEVATION - ALT 2
NOT TO SCALE

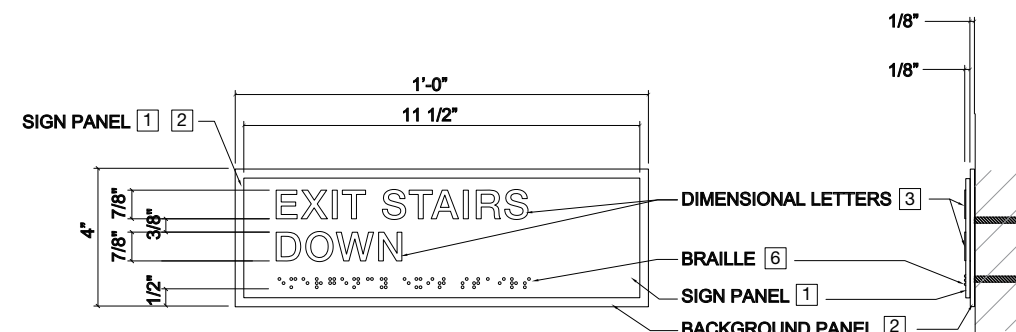

3 FRONT ELEVATION
NOT TO SCALE

4 SIDE ELEVATION
NOT TO SCALE

Sign Type Design

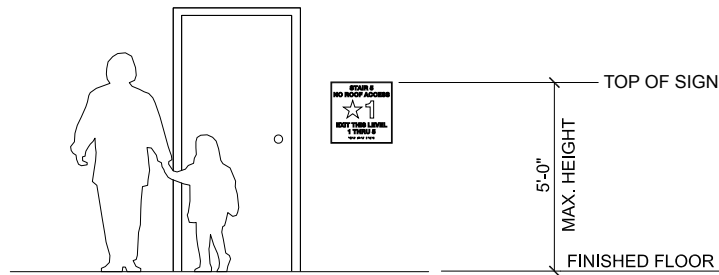

4 CONTEXT ELEVATION
SCALE: 3/16" = 1'-0"

GENERAL NOTES:

1. ADA AND LOCAL FIRE CODE COMPLIANT WALL MOUNTED IDENTIFICATION PANEL.
2. BACKGROUND PANEL TO BE STAINLESS STEEL WITH BRUSHED FINISH ON FACE AND EDGES. ADHERE TO PHOTOPOLYMER PANEL IN A TAMPERPROOF MANNER.
3. SIGN PANEL TO BE 1/8" THICK PHOTOPOLYMER PANEL.
4. SIGN TO BE FLUSH MOUNTED TO WALL WITH THREADED WELDED STUDS AND SILICONE ADHESIVE AS REQUIRED.
5. PHOTOPOLYMER BRAILLE TO BE GRADE 2 AND PAINTED TO MATCH BACKGROUND COLOR
6. VERIFY WITH LAWA FOR SPECIFIC MESSAGES PER SIGN LOCATION.

NOTE:
THE STAR INDICATE THE ACTUAL DISCHARGE LEVEL VARIES.

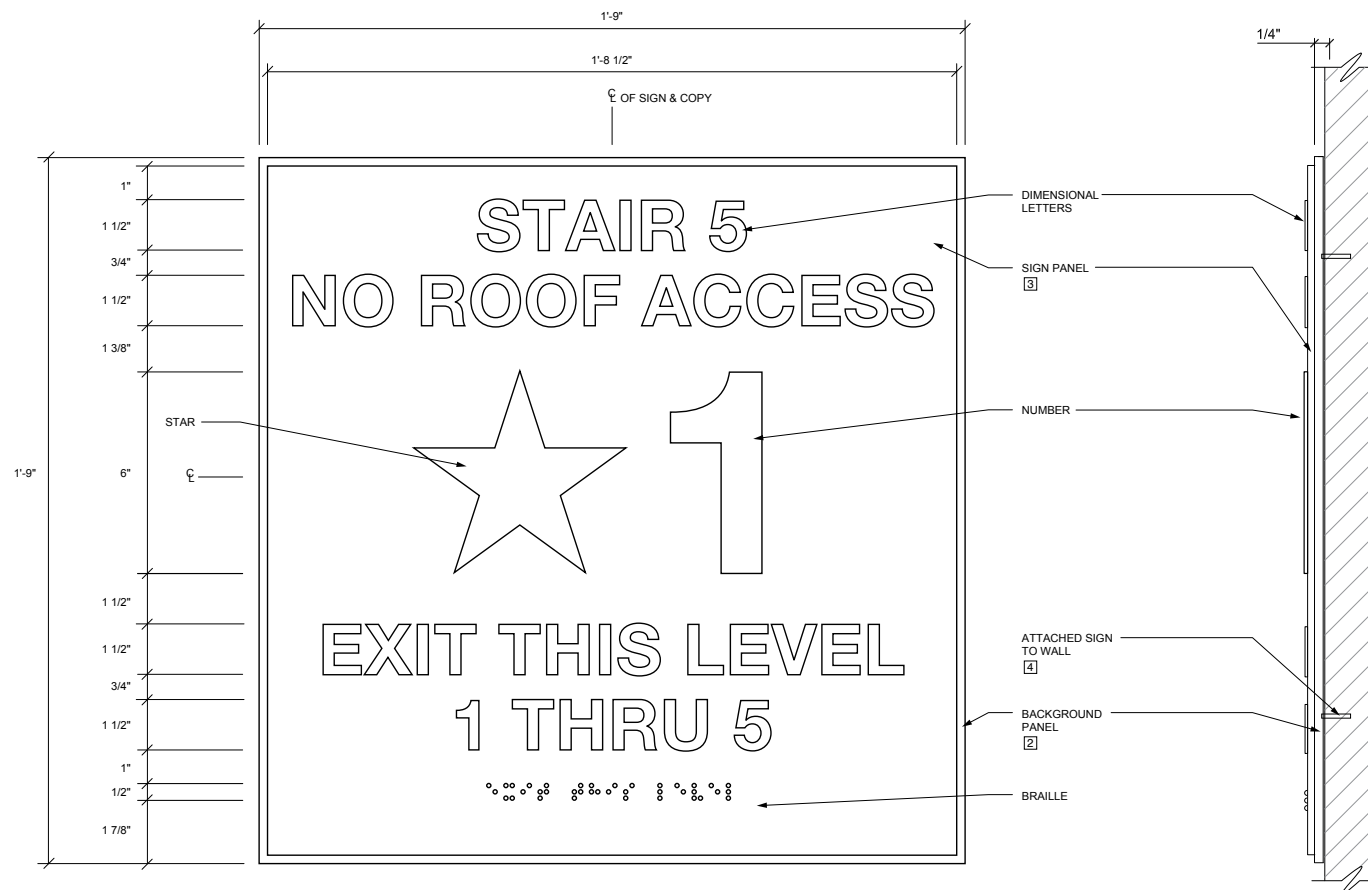

1 FRONT ELEVATION
NOT TO SCALE

2 SIDE ELEVATION
NOT TO SCALE



Area of Assistance Sign

M_8

Sign Type Design



GENERAL NOTES:

1. ADA COMPLIANT WALL MOUNTED IDENTIFICATION PANEL.
2. SIGN BACKGROUND TO BE 1/8" THICK ALUMINUM WITH BRUSHED FINISH ON FACE AND EDGES. ADHERE TO PHOTOPOLYMER PANEL IN A TAMPERPROOF MANNER.
3. COPY AND GRAPHICS TO BE SCREEN PRINTED IN COLORS INDICATED.
4. MAP TO BE SCREEN PRINTED IN COLORS INDICATED. MAP TO BE UNIQUE PER SIGN LOCATION. MAP SHOWN IS FOR REFERENCE ONLY. MAP ART TO BE PROVIDED BY GENERAL CONTRACTOR.
5. SIGN TO BE FLUSH MOUNTED TO WALL WITH THREADED WELDED STUDS AND SILICONE ADHESIVE AS REQUIRED.
6. SIGNAGE SHOWN IS FOR PLACEMENT PURPOSES ONLY. LAWA TO PROVIDE MESSAGE SCHEDULE FOR SPECIFIC MESSAGES PER SIGN LOCATION.

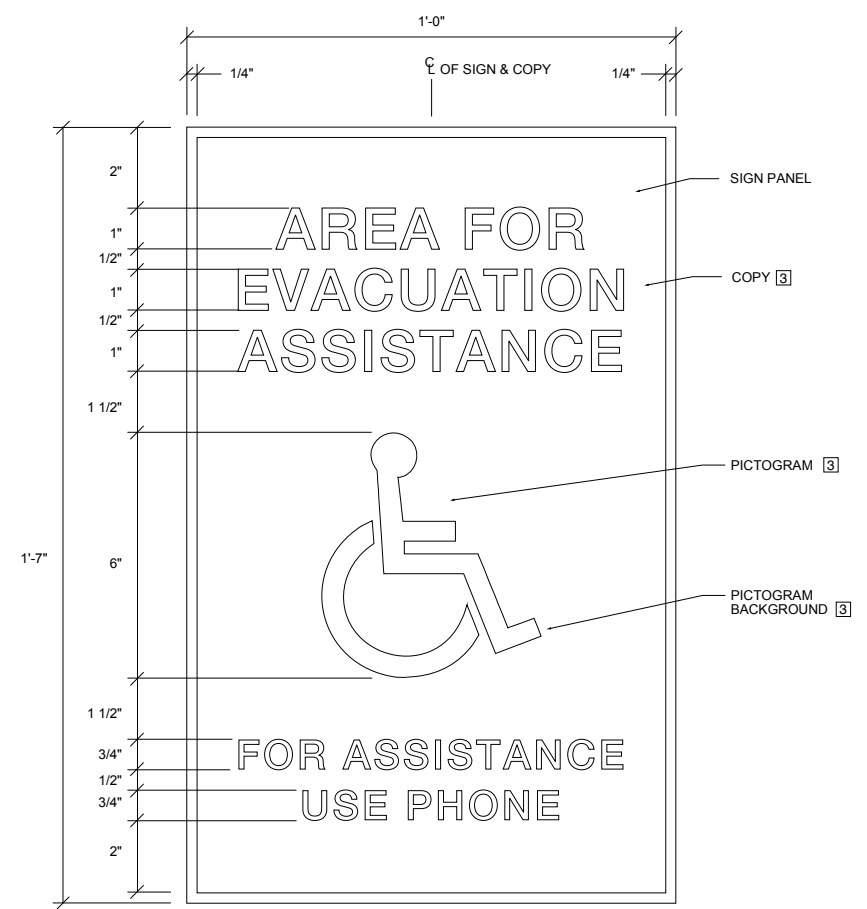

1 FRONT ELEVATION
NOT TO SCALE

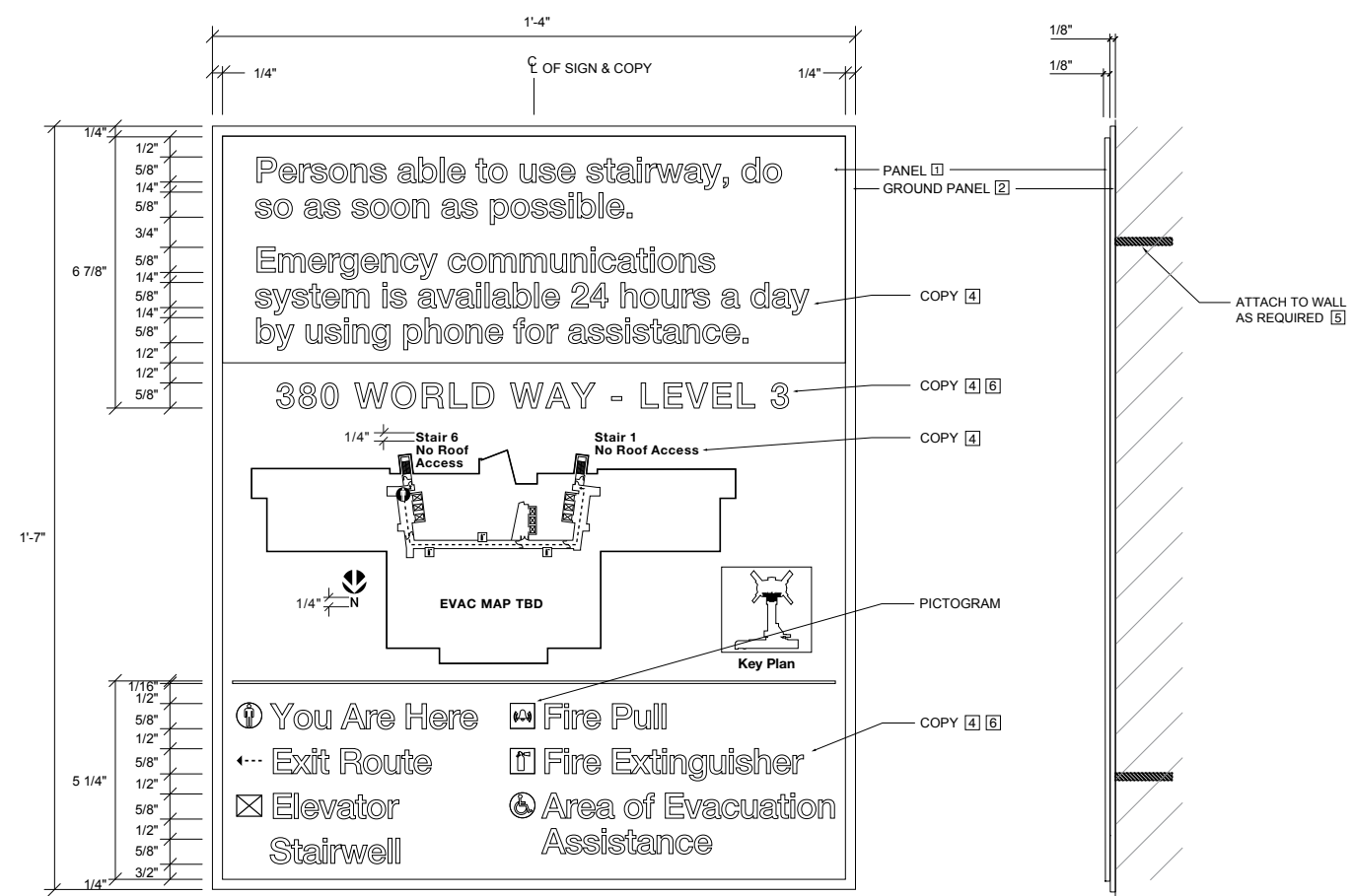

2 FRONT ELEVATION
NOT TO SCALE

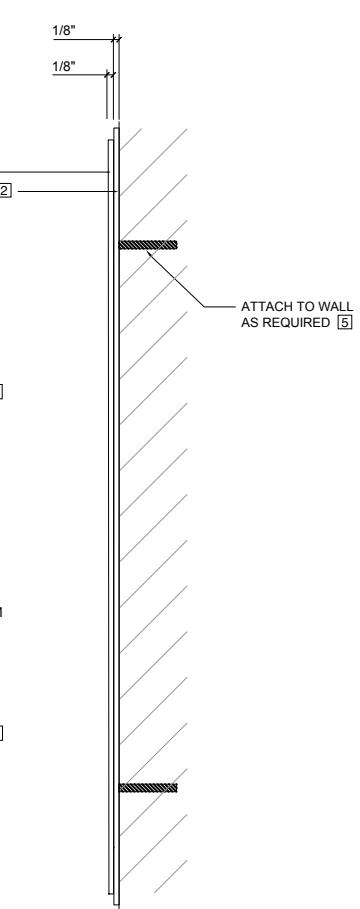

3 SIDE ELEVATION
NOT TO SCALE

Area of Evacuation Map/Stair Identity

Sign Type Design

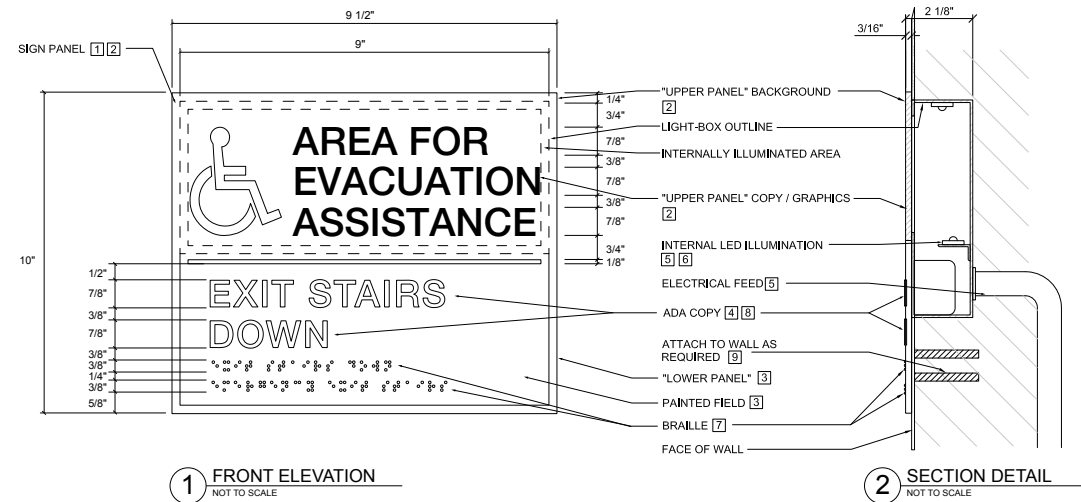

GENERAL NOTES:

1. TWO PART FABRICATED ALUMINUM AND ACRYLIC SIGN PANEL WITH INTERNAL ILLUMINATION, RECESS INTO WALL.
2. "UPPER PANEL" TO BE TRANSLUCENT ACRYLIC WITH OPAQUE PAINTED OR VINYL FIELD WITH SHOW-THRU INTERNALLY ILLUMINATED COPY AND ACCESSIBLE LOGO. ILLUMINATION TO MEET CODE REQUIREMENTS FOR THIS SIGN. PROVIDE INCONSPICUOUS MAINTENANCE ACCESS.
3. "LOWER PANEL" TO BE BRUSHED ALUMINUM PANEL WITH PAINTED FIELD. COPY AND GRAPHICS TO BE SCREEN PRINTED IN COLORS INDICATED.
4. ADA COPY TO BE DIMENSIONAL AND PAINTED IN COLOR NOTED. ADA COPY TO MEET ADA REQUIREMENTS.
5. 120V CIRCUIT AND BATTERY BACK-UP AS REQUIRED FOR LOW VOLTAGE LED POWER SUPPLY.
6. COORDINATE WITH GENERAL CONTRACTOR TO PROVIDE WALL RECESS AND ELECTRICAL FEED AS REQUIRED.
7. BRAILLE TO BE GRADE 2 WITH COLOR TO MATCH BACKGROUND.
8. MESSAGE SHOWN IS FOR PLACEMENT PURPOSES ONLY. LAWA TO PROVIDE SPECIFIC MESSAGES PER LOCATION OF SIGN.
9. SIGN TO BE FLUSH MOUNTED ONTO EXISTING FACILITY WALL IN A TAMPER-PROOF MANNER.

NOTE:

ALL TEXT MUST COMPLY WITH THE ADA STANDARDS, INCLUDING FONT SIZE, COLOR CONTRAST AND READABILITY FROM A DISTANCE.

SEE PAGE 51 FOR A REDUCE SIZE EVACUATION PLAN, ONLY IF WALL AREA DOES NOT FIT THE SIZE OF THESE SIGNS.

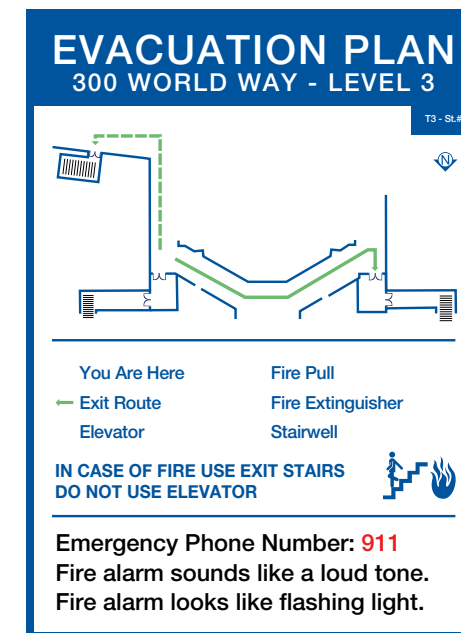
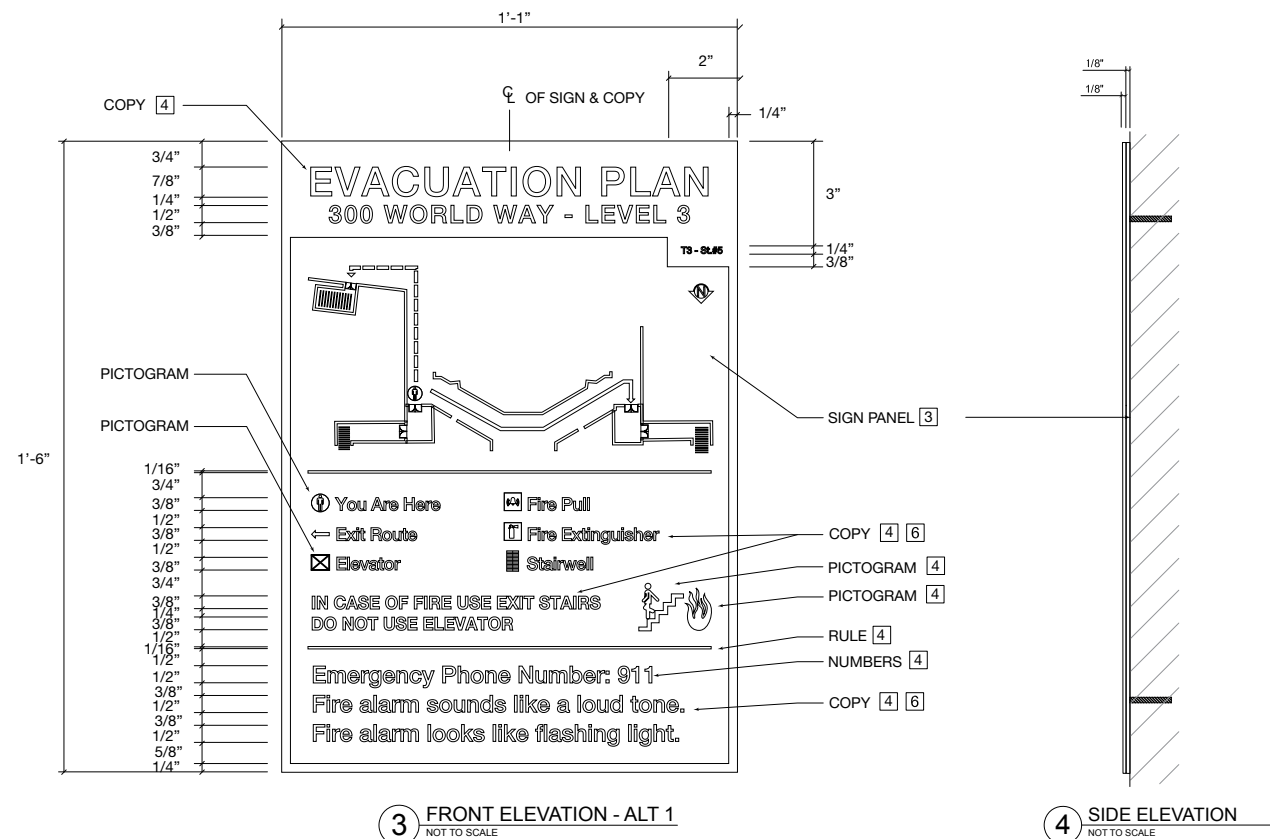



GENERAL NOTES:

1. TACTILE WALL MOUNTED IDENTIFICATION PANEL.
2. SIGN BACKGROUND TO BE 1/8" THICK ALUMINUM WITH BRUSHED FINISH ON FACE AND EDGES. ADHERE TO PHOTOPOLYMER PANEL IN A TAMPERPROOF MANNER.
3. SIGN PANEL TO BE 1/8" THICK PHOTOPOLYMER PANEL WITH 1/32" RAISED GRAPHICS WITH BRAILLE.
4. PHOTOPOLYMER ADA COMPLIANT LETTERS TO BE MINIMUM 1/32" PROTRUSION FROM FACE OF SIGN AND SCREEN TIPPED IN COLOR NOTED.
5. PHOTOPOLYMER BRAILLE TO BE GRADE 2 AND PAINTED TO MATCH BACKGROUND.
6. SIGN TO BE FLUSH MOUNTED TO WALL WITH THREADED WELDED STUDS AND SILICONE ADHESIVE AS REQUIRED.
7. PROVIDE SIGNAGE IN REQUIRED AREAS WITH PROPER MESSAGING PER ADA AND LOCAL CODES.

NOTE:
CA-COMPLIANT GRADE 2 BRAILLE BY A CERTIFIED GRADE 2 BRAILLE TRANSLATOR.

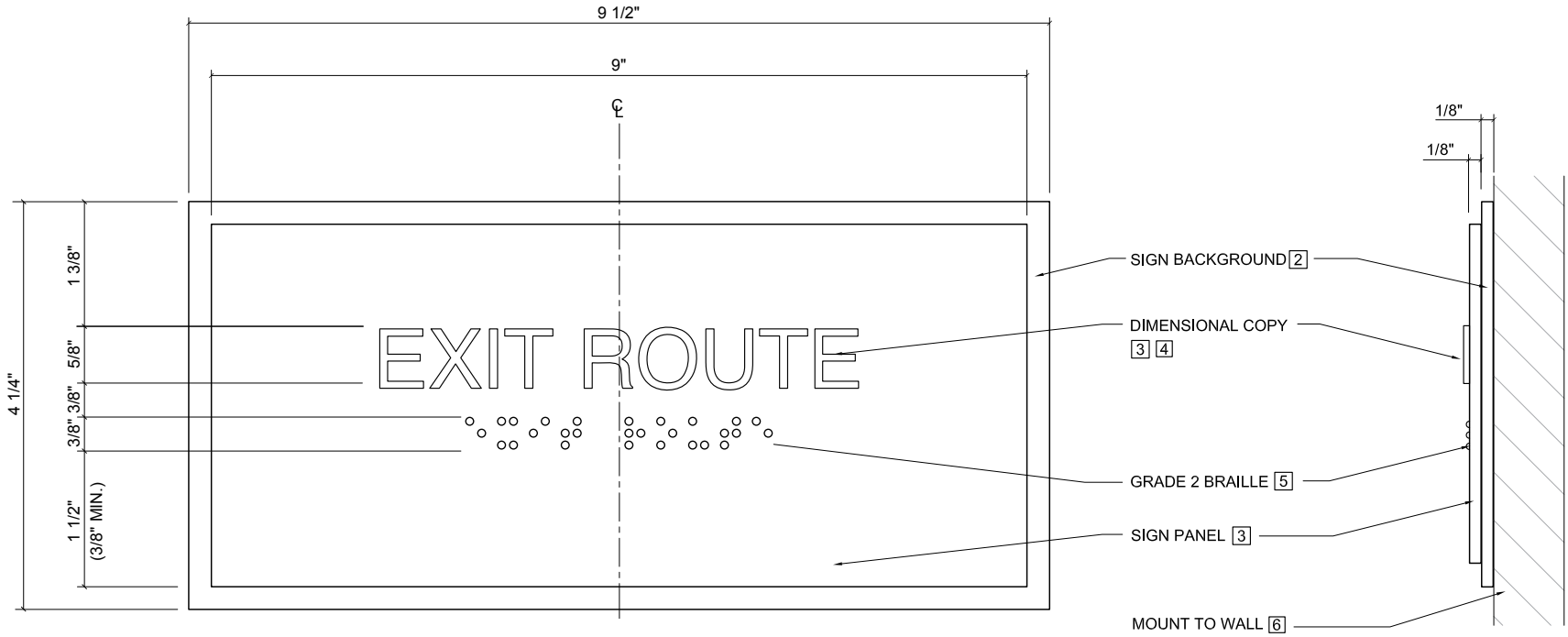

1 FRONT ELEVATION
NOT TO SCALE

2 SIDE ELEVATION
NOT TO SCALE



GENERAL NOTES:

1. DOOR MOUNTED ALUMINUM SIGN PANEL WITH SCREEN PRINTED COPY AND SYMBOLS,
2. SIGN PANEL TO BE 1/16" THICK BRUSHED ALUMINUM WITH PANTED CENTER.
3. COPY, GRAPHICS AND BACKGROUND FIELD TO BE MASKED AND PAINTED OR SCREENPRINTED.
4. MOUNT TO DOOR WITH VHB TAPE AND SILICONE ADHESIVE AS REQUIRED. FOR GLASS DOOR INSTALLATIONS ADHERE WHITE VINYL CUT TO SIGN PANEL PROPORTIONS TO FIRST SURFACE OF GLASS PRIOR TO INSTALLATION OF SIGN PANEL.
5. CONFIRM MESSAGING WITH LAWA PRIOR TO FABRICATION OF SIGNS.

NOTE:
MINIMUM TEXT HEIGHT 5/8".

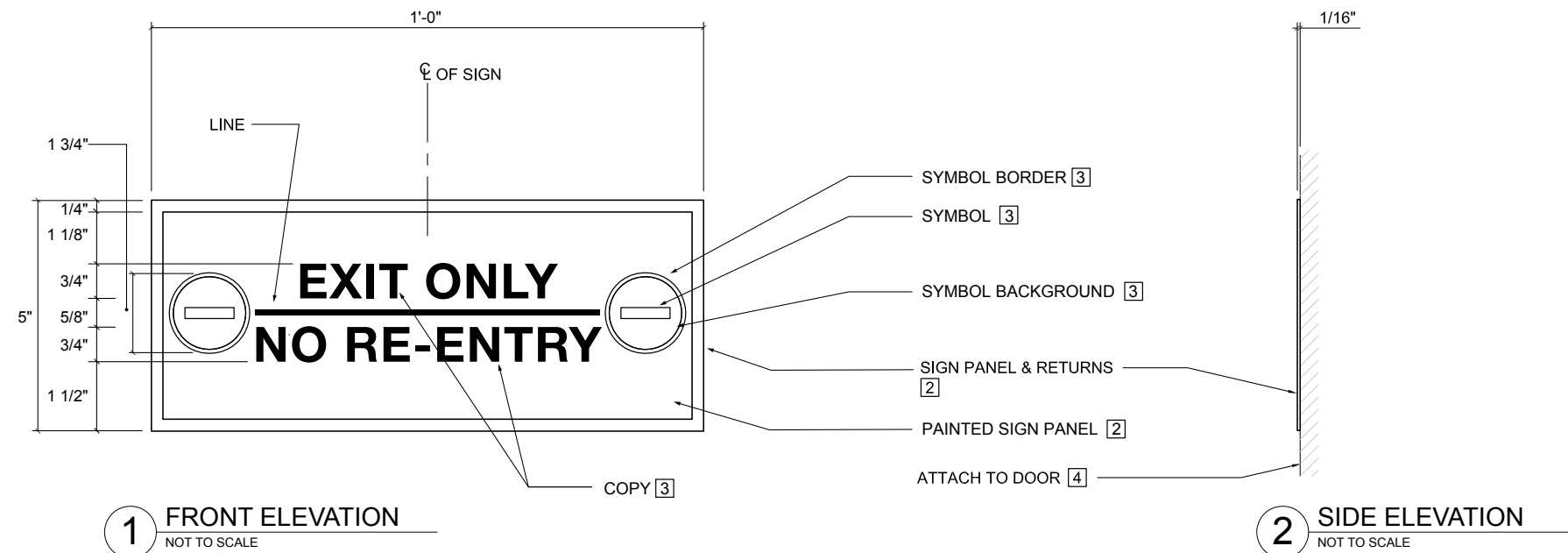

Restricted Area – Door

M_12

Sign Type Design

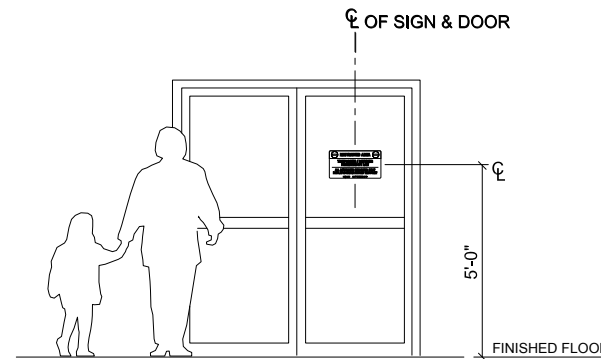
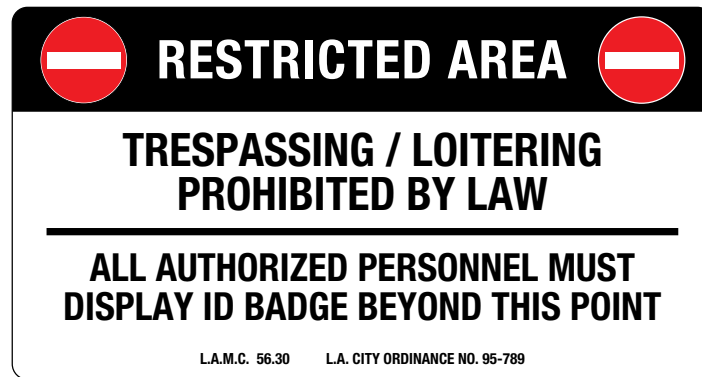

7 CONTEXT ELEVATION
NOT TO SCALE

GENERAL NOTES:

1. SCREENPRINTED GRAPHICS ON OPAQUE WHITE VINYL FILM WITH ADHESIVE BACKING.
2. MOUNT TO FACE OF EXISTING FACILITY DOOR. GLASS DOOR INSTALLATIONS TO HAVE WHITE POLYESTER FILM PROFILE CUT TO MATCH SIGN, ATTACH TO SECOND SURFACE OF GLASS. COLOR TO MATCH RED.
3. REFER TO LAWA FOR EXACT MESSAGE PER LOCATION OF SIGN.
4. COPY AND SYMBOLS TO BE SCREENPRINTED, COLOR AS INDICATED.
5. LAYOUT "A" TO BE ORDERED THROUGH U.S. CUSTOMS BORDER PROTECTION SEAL TO BE PRINTED BY U.S. CUSTOMS BORDER PROTECTION APPROVED PRINTER ONLY.

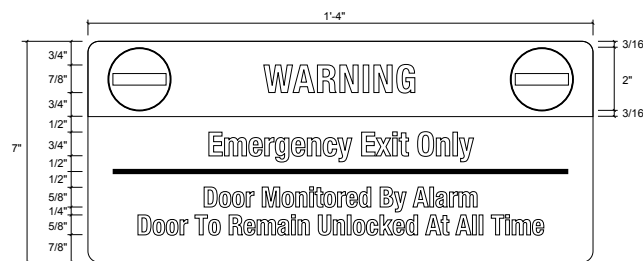

1 LAYOUT "A"
NOT TO SCALE

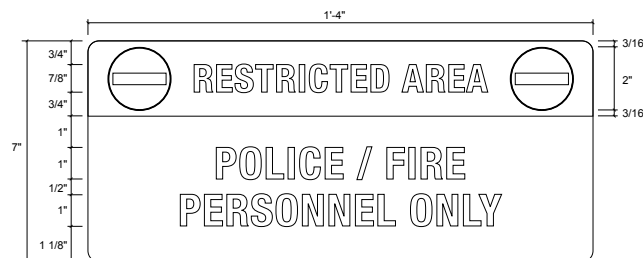

2 LAYOUT "B"
NOT TO SCALE



3 LAYOUT "C"
NOT TO SCALE

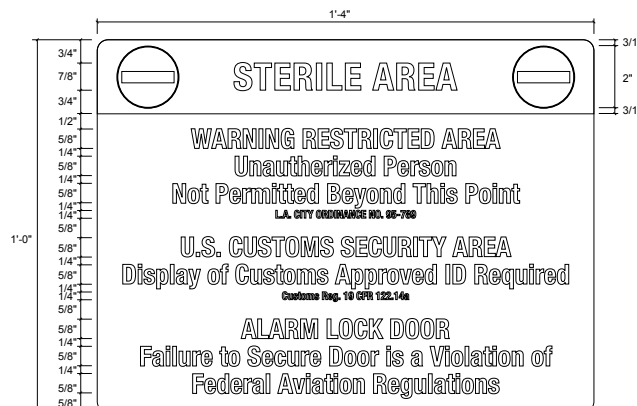

4 LAYOUT "D"
NOT TO SCALE



6 LAYOUT "F"
NOT TO SCALE

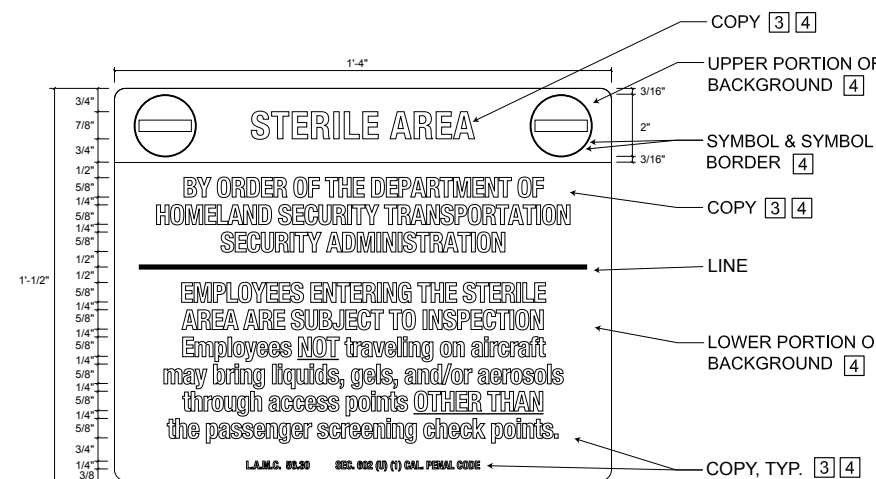

5 LAYOUT "E"
NOT TO SCALE

GENERAL NOTES:

- 1] NON-ILLUMINATED, POSTER CABINET WITH BRUSHED STAINLESS STEEL FRAME, INCONSPICUOUS CONTINUOUS HINGE, NON-GLARE GLASS, AND TWO LOCKS KEYED ALIKE. MOUNT TO WALL WITH WALL ANCHORS AS REQUIRED.

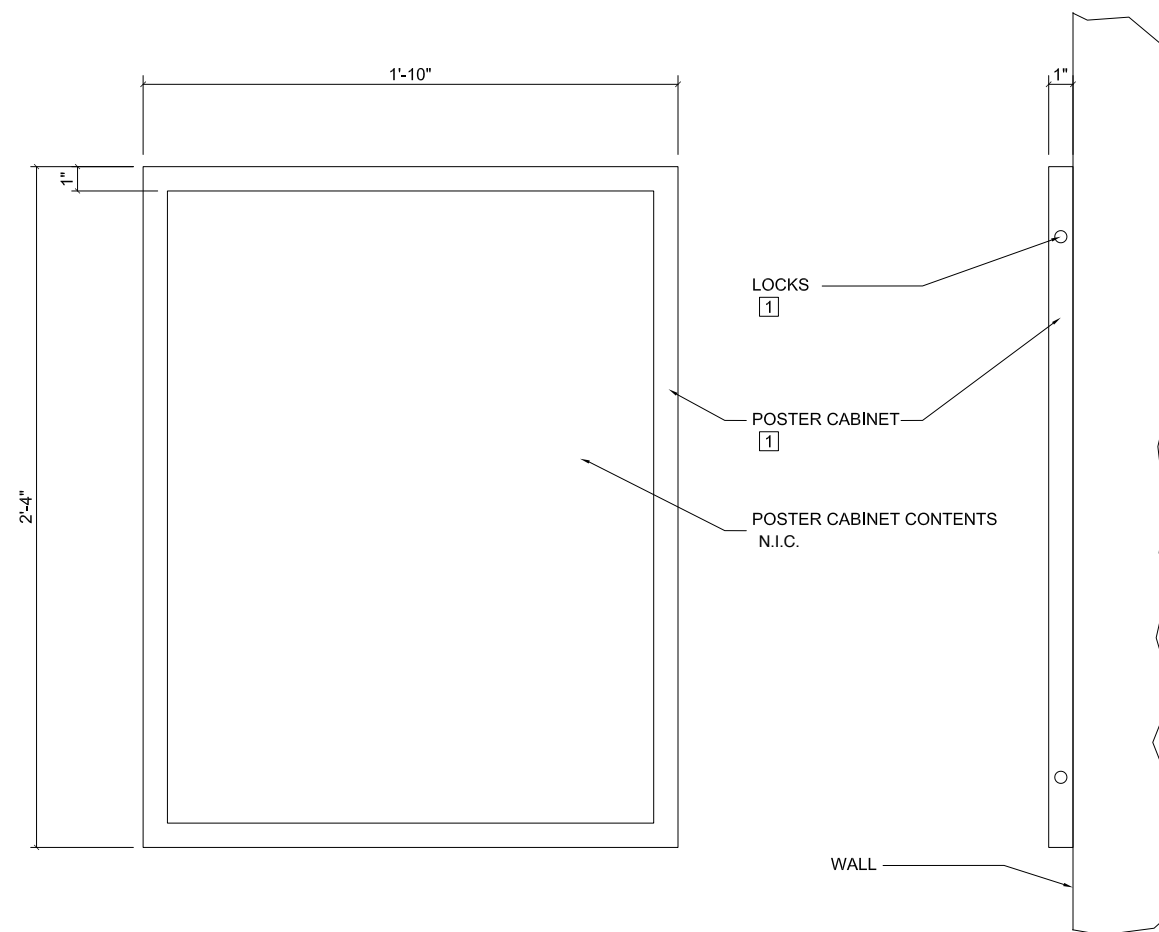

1 FRONT ELEVATION
NOT TO SCALE

2 SIDE ELEVATION
NOT TO SCALE

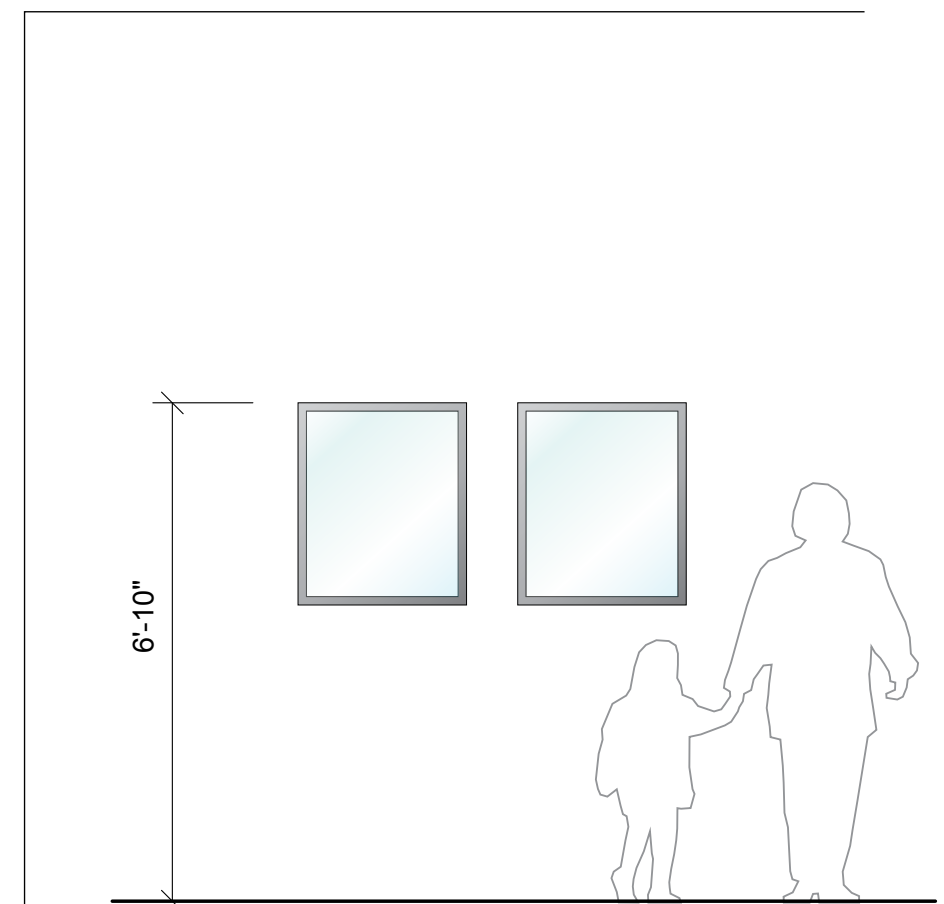

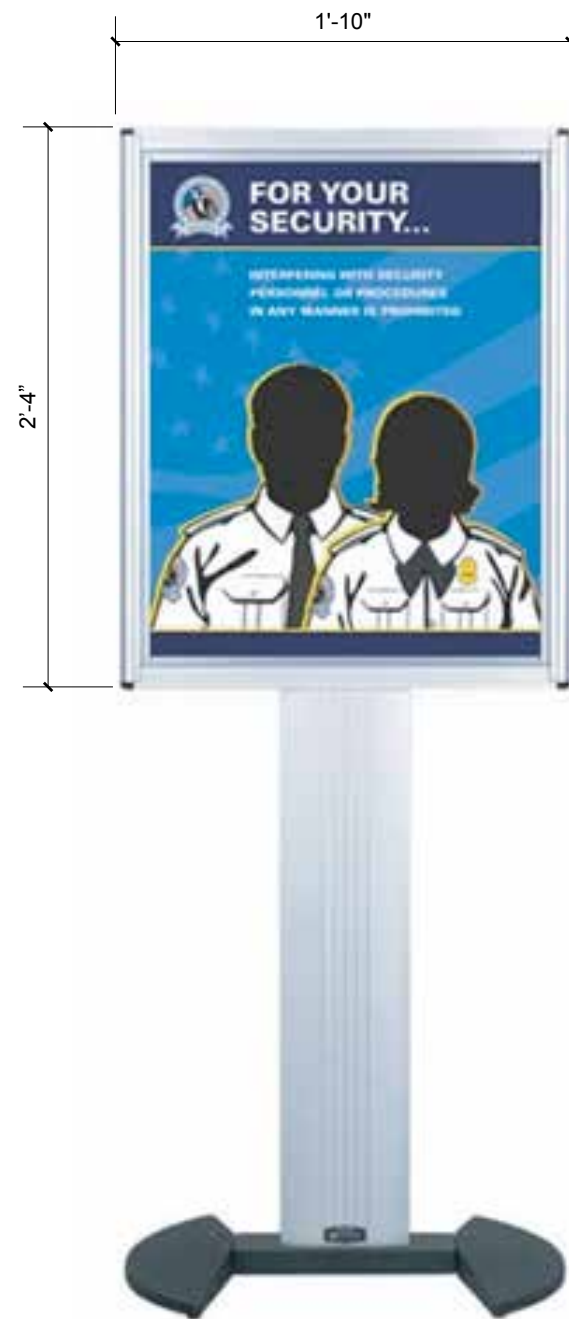

1 FRONT ELEVATION
NOT TO SCALE

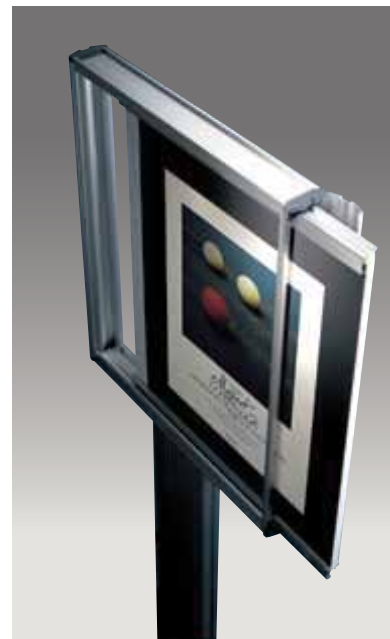

2 DETAIL
NOT TO SCALE

GENERAL NOTES:

1. FREESTANDING PORTABLE POSTER STANCHION.
2. 22"X28" DIRECTRAC CURVED BASE, WITH DIRECTRAC POSTER CARTRIDGE. CATALOG NUMBER #50-4501A/SA/SET, SATIN ALUMINUM FINISH. PRE-APPROVED FOR TSA USAGE. LAVI INDUSTRIES, LAVI.COM 27810 AVENUE HOPKINS VALENCIA, CA 91355 SALES@LAVI.COM PHONE: (888) 285-8605
3. TSA TO PROVIDE POSTER INSERTS.



1 FRONT ELEVATION
NOT TO SCALE



2 DETAIL
NOT TO SCALE

GENERAL NOTES:

1. FREESTANDING PORTABLE POST STANCHION.
2. 22" X 28" VERTICAL TRADITIONAL SIGN
3. 72" POSTS STAND WITH SLOPED BASE, SATIN ALUMINUM FINISH.
PRE-APPROVED FOR TSA USAGE.
LAVI INDUSTRIES, LAVI.COM
27810 AVENUE HOPKINS
VALENCIA, CA 91355
SALES@LAVI.COM
PHONE: (888) 285-8605
4. AIRLINES TO PROVIDE POSTER INSERTS.

NOTE:

IF SIGNS / POSTERS ON THESE STANCHIONS PROVIDE DIRECTION TO OR INFORMATION ABOUT INTERIOR OR EXTERIOR SPACES AND FACILITIES, THEY MUST COMPLY WITH ACCESSIBILITY REQUIREMENTS (CBC 11B-216.3). MOST NOTABLY, SINCE THIS STANCHION IS QUITE TALL, CHARACTERS LOCATED > 70" AFF (TO <=/ 120" AFF) MEASURED TO THEIR BASELINE MUST BE AT LEAST 2" TALL DEPENDING ON VIEWING DISTANCE (CBC 11B-703.5.5).



GENERAL NOTES:

- 1. PAINTED GRAPHIC ONTO FLOOR SURFACE.
- 2. PAINT TO BE SLIP RESISTANT
- 3. LAWA TO PROVIDE LOCATIONS OF SIGNS.

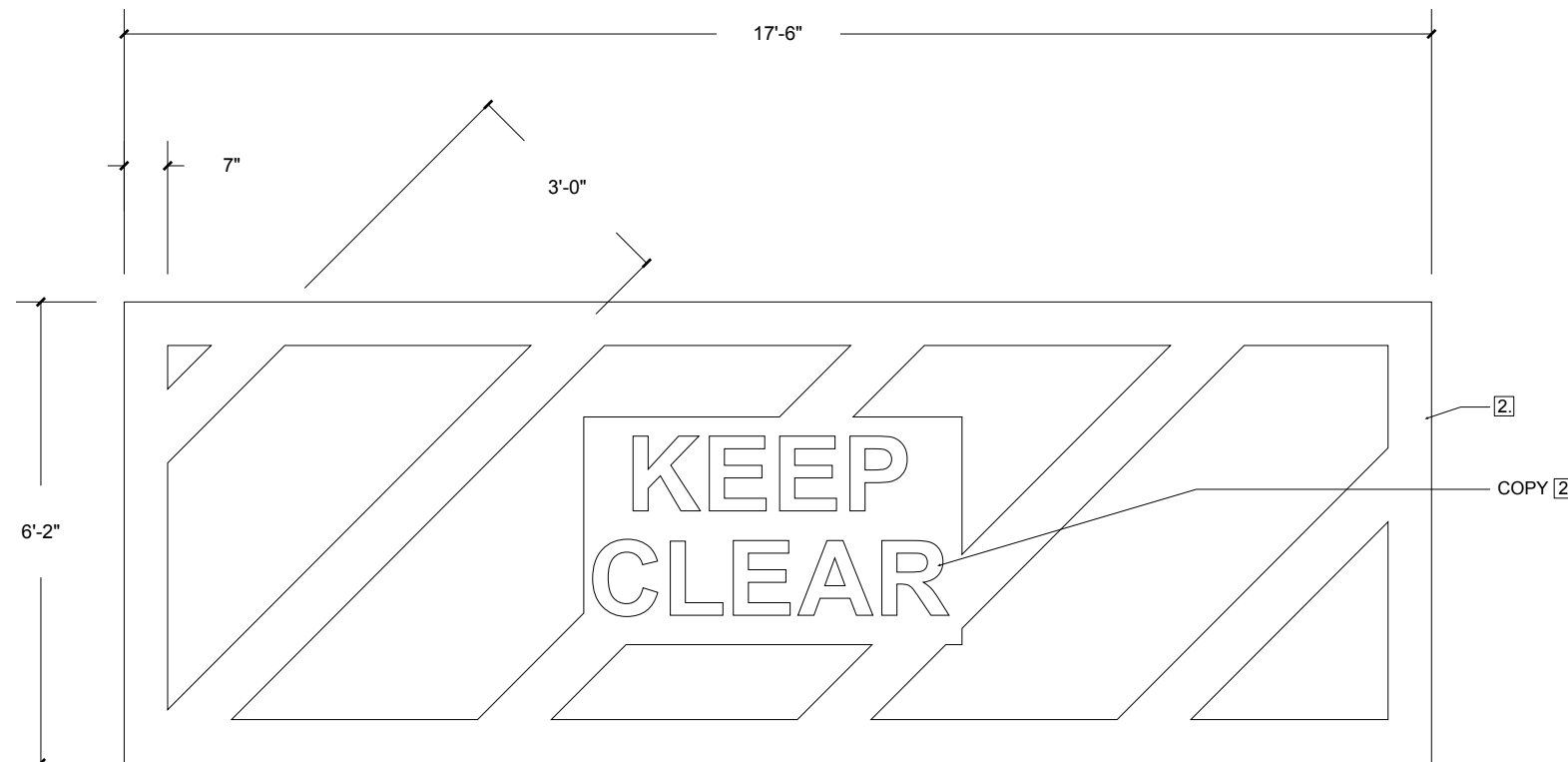

1 FRONT ELEVATION
NOT TO SCALE



GENERAL NOTES:

1. WALL MOUNTED SIGN PANEL.
2. SIGN PANEL TO BE PAINTED ALUMINUM WITH REFLECTIVE VINYL GRAPHICS.
3. MOUNT TO WALL WITH VHB TAPE AND SILICONE ADHESIVE AS REQUIRED.
4. VERIFY LOCATIONS, MESSAGING AND QUANTITIES WITH LAWA.
5. 5/8" MINIMUM TEXT HEIGHT.

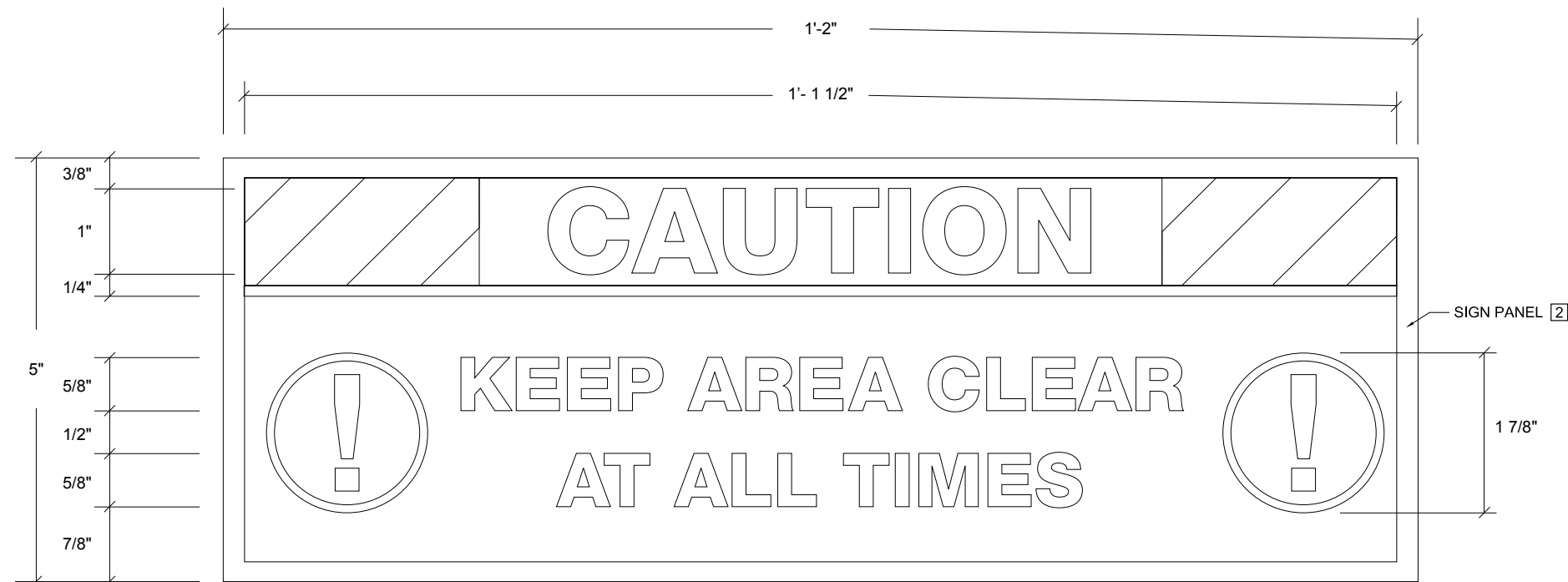

1 FRONT ELEVATION
NOT TO SCALE

GENERAL NOTES:

1. PAINTED 6" DIAMETER RIGID PVC TUBE.
2. COPY AND STRIPES TO BE APPLIED REFLECTIVE 3M VINYL.
3. S. STL. BUTTON HEAD FASTENER SECURE INSERT INTO ALUMINUM TUBE.
4. CLOSURE FOR TUBE END WITH FLUSH CAP, MAKE CAP REMOVABLE, PAINT END CAP TO MATCH TUBE.
5. STAINLESS STEEL CABLE AND FITTINGS TO SUSPEND TUBE.
6. COORDINATE WITH GC FOR CLEARANCE HEIGHT DIMENSIONS.
7. 3" MINIMUM TEXT HEIGHT.

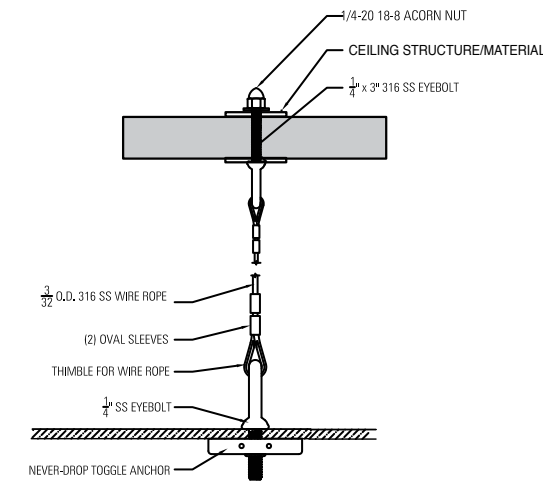
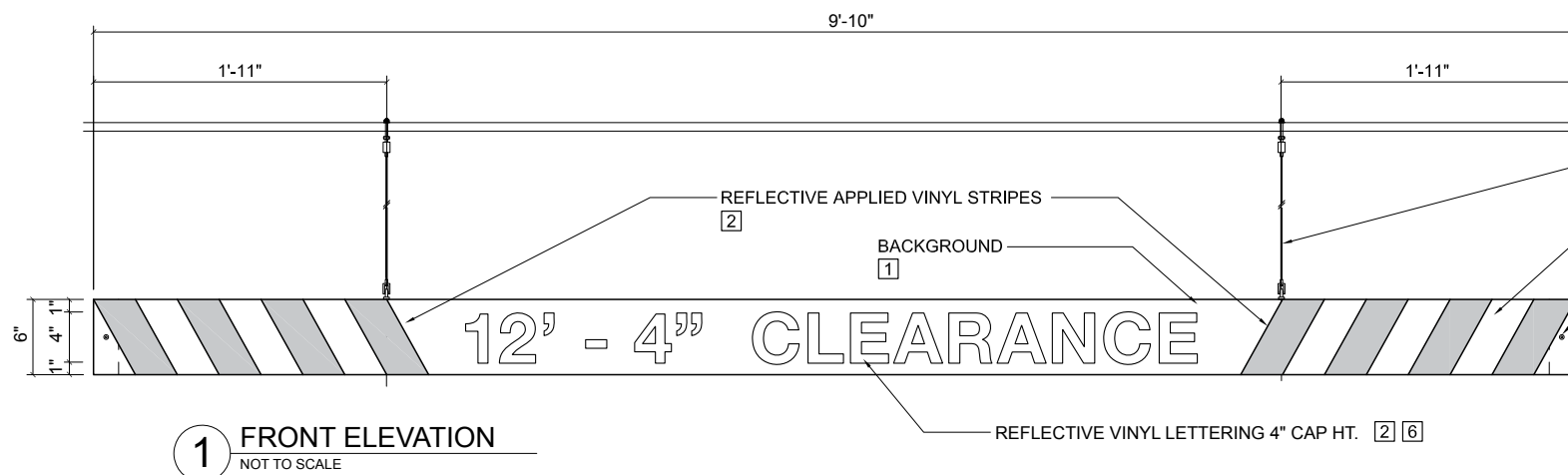
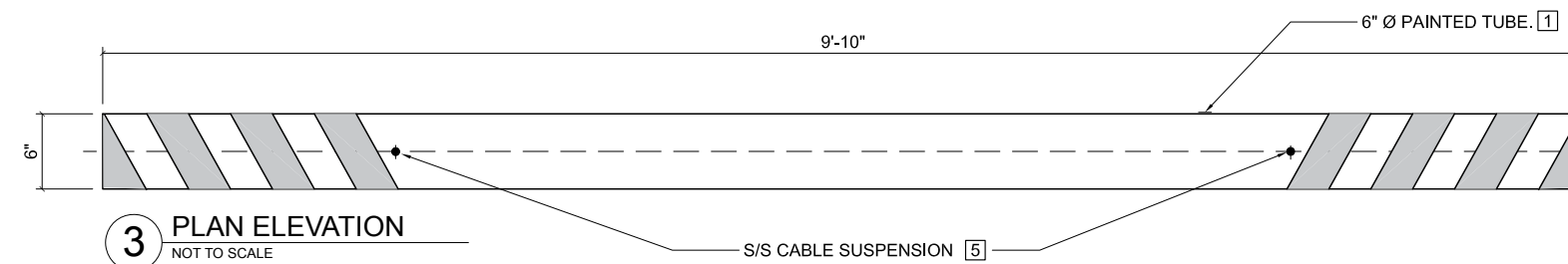

ENLARGED SUSPENSION DETAIL

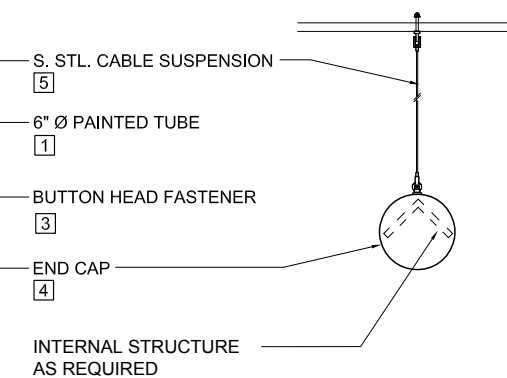

2 END ELEVATION NOT TO SCALE

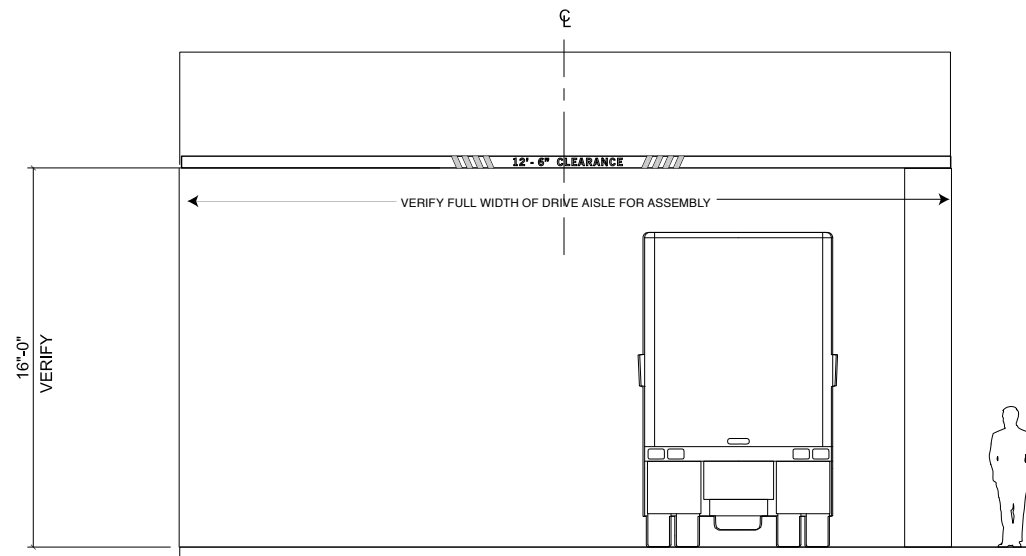

2 CONTEXT ELEVATION
NOT TO SCALE

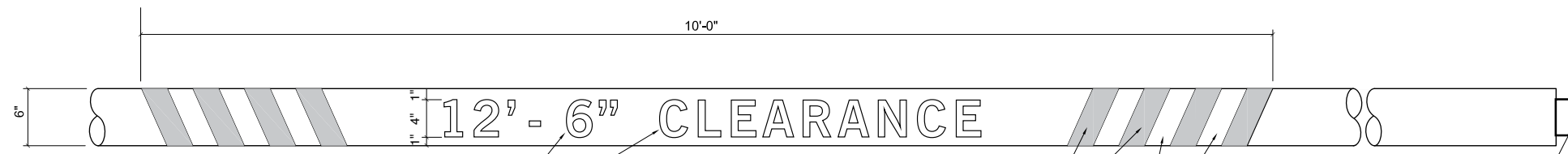
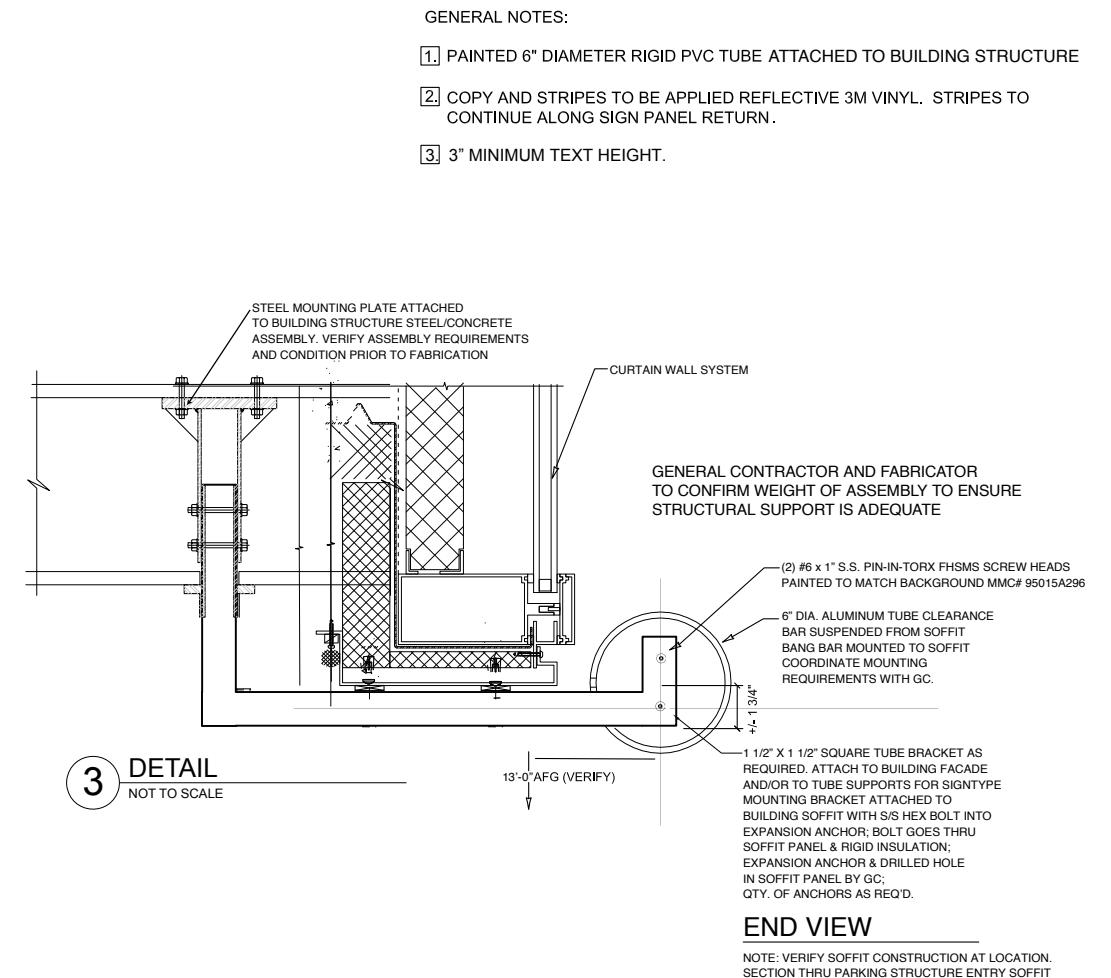

1 FRONT ELEVATION
NOT TO SCALE

Evacuation Plan Reduced Size

M_20

Sign Type Design

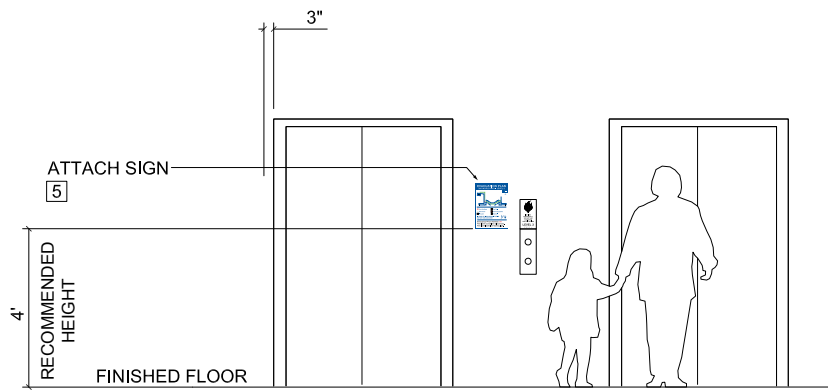

3 CONTEXT ELEVATION
NOT TO SCALE

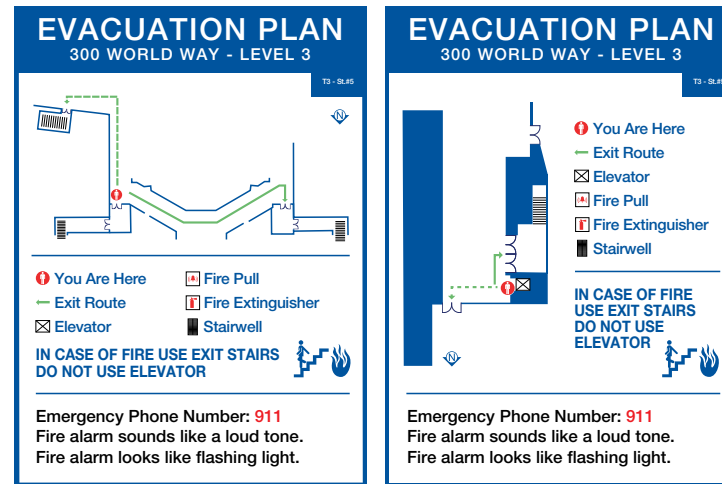

GENERAL NOTES:

1. EVACUATION PLAN REGULATION SIGNAGE.
2. SIGN BACKGROUND TO BE 1/8" THICK ALUMINUM WITH BRUSHED FINISH ON FACE AND EDGES.
3. 1/8" THICK PAINTED ACRYLIC SIGN PANEL TO BE ADHERED TO SIGN BACKGROUND IN A PERMANENT MANNER.
4. ALL COPY AND GRAPHICS TO BE SCREEN PRINTED IN COLORS INDICATED.
5. FLUSH MOUNT TO EXISTING WALL WITH WELDED THREADED STUDS AND SILICONE ADHESIVE AS REQUIRED.
6. LAWYER TO PROVIDE BASE MAP ART AND SPECIFIC MESSAGES PER LOCATION OF SIGN.

NOTE:
USE THIS REDUCE SIZE EVACUATION PLAN SIGN ONLY IF OTHER SIGNS ON PAGE 34, 37, AND 40 DOES NOT FIT THE WALL AREA.

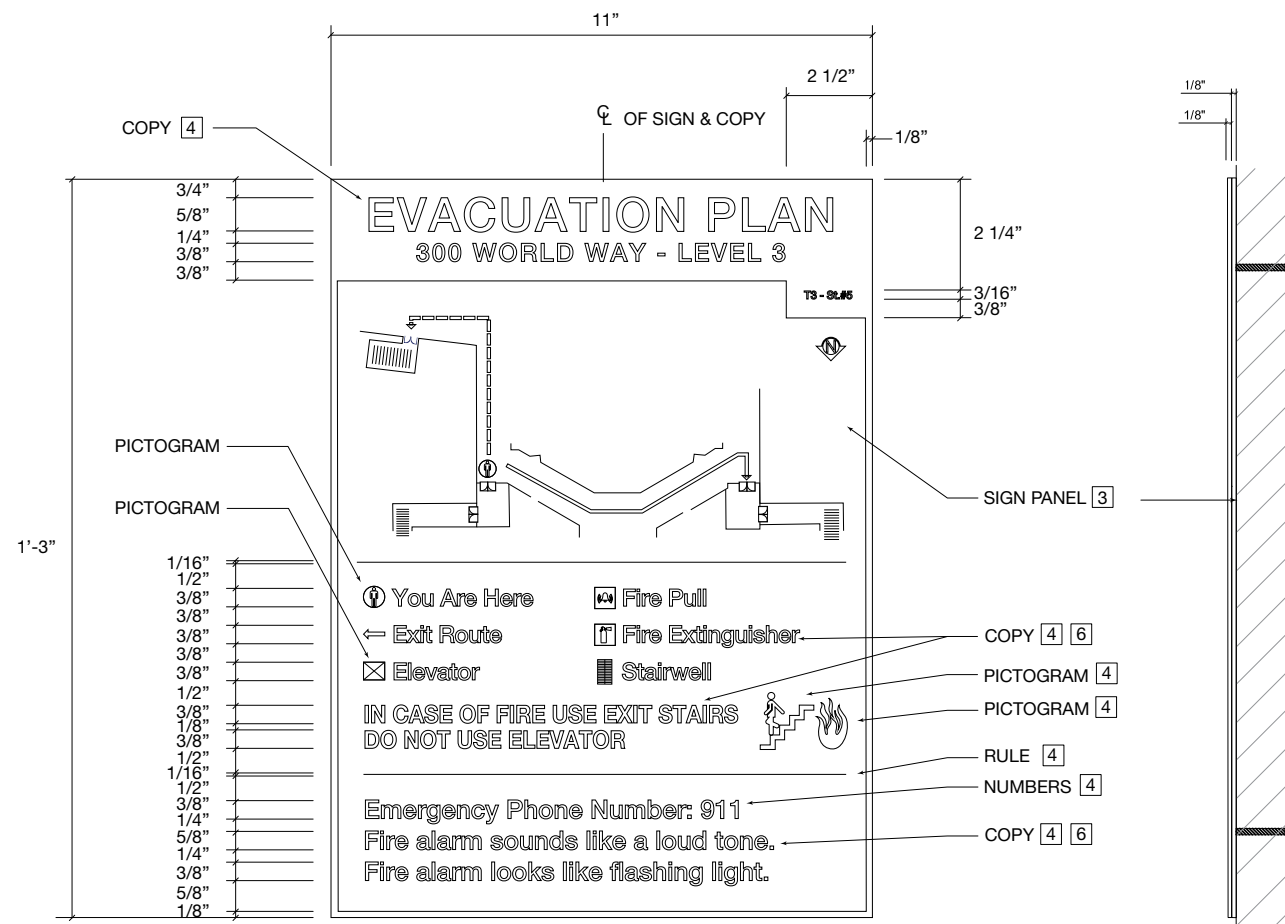

1 FRONT ELEVATION - ALT 1
NOT TO SCALE

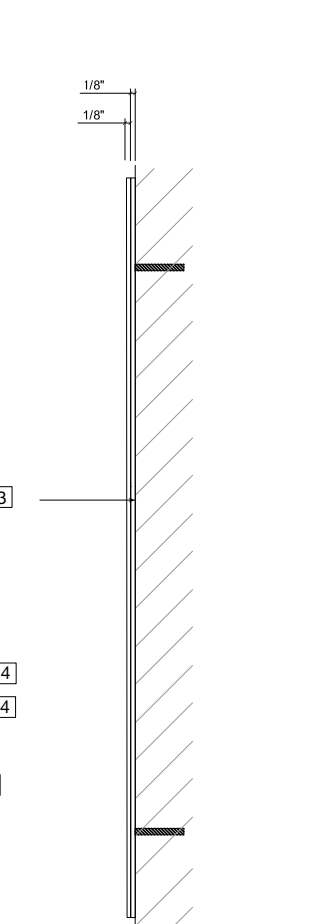

2 SIDE ELEVATION
NOT TO SCALE

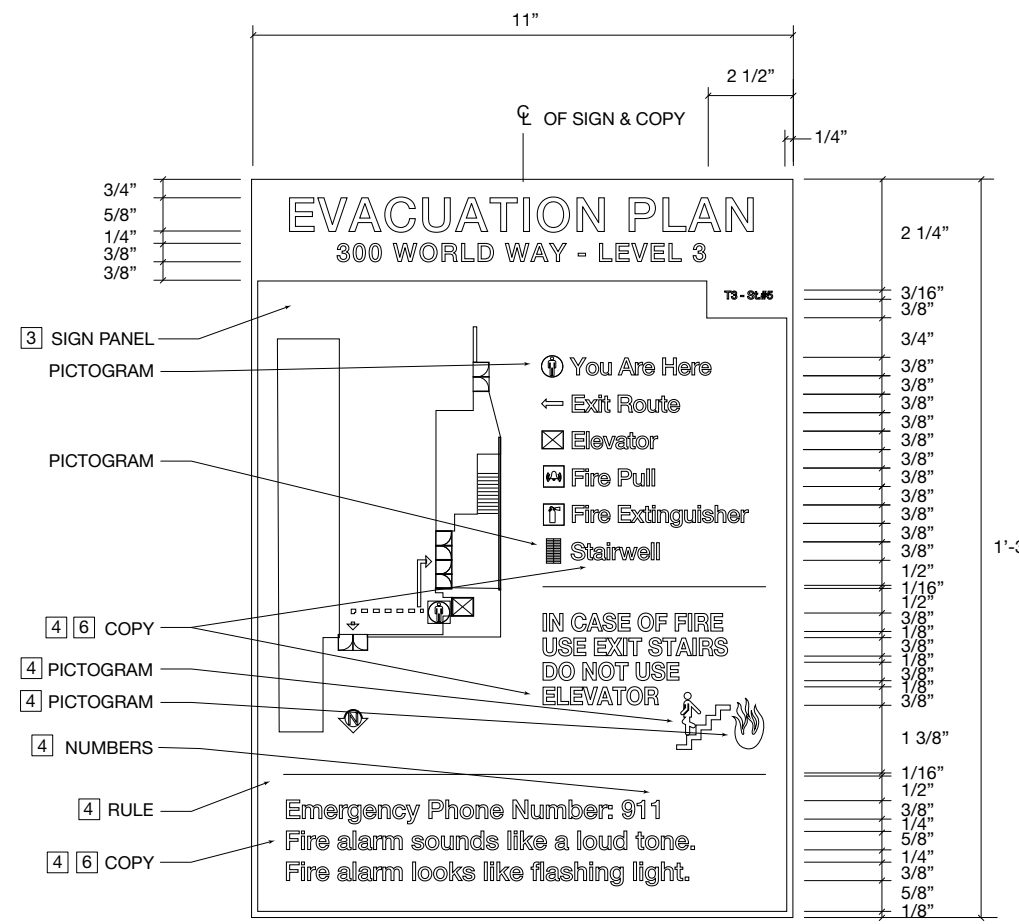

3 FRONT ELEVATION - ALT 2
NOT TO SCALE



GENERAL NOTES:

1. ADA COMPLIANT ROOM IDENTIFICATION SIGNAGE.
2. SIGN PANEL TO BE 1/4" THICK PHOTOPOLYMER MOUNTED TO WALL.
3. PHOTOPOLYMER DIMENSIONAL LETTERS TO BE MINIMUM 1/32" PROTRUSION FROM SIGN FACE AND SCREEN-TIPPED IN COLOR INDICATED.
4. PHOTOPOLYMER GRADE 2 BRAILLE TO BE ADA COMPLIANT WITH COLOR TO MATCH BACKGROUND COLOR.
5. SIGN TO BE MOUNTED TO WALL WITH VHB TAPE AND SILICONE ADHESIVE AS REQUIRED.
6. COORDINATE WITH LAWA FOR SPECIFIC LOCATIONS AND MESSAGES PER SIGN LOCATION.

NOTE:

DUAL-PURPOSE SIGN MUST INCLUDE BOTH VISUAL AND TACTILE FORMATS.

SPACING BETWEEN THE BASELINES OF SEPARATE LINES OF CHARACTERS MUST BE 135% MINIMUM AND 175% MAXIMUM OF THE CHARACTER HEIGHT (CBC 11B-703.2.8). NEITHER A BASELINE-TO-BASELINE DIMENSION NOR A DIMENSION BETWEEN LINES OF RAISED TEXT IS PROVIDED.

CA-COMPLIANT GRADE 2 BRAILLE BY A CERTIFIED GRADE 2 BRAILLE TRANSLATOR.

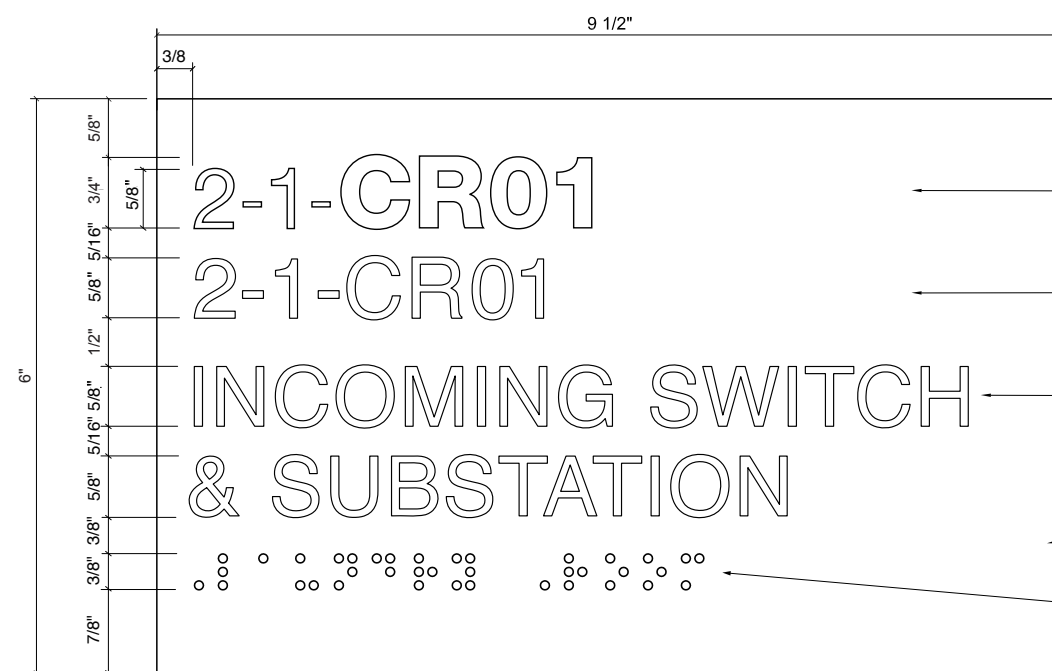

2 Front Elevation
NOT TO SCALE

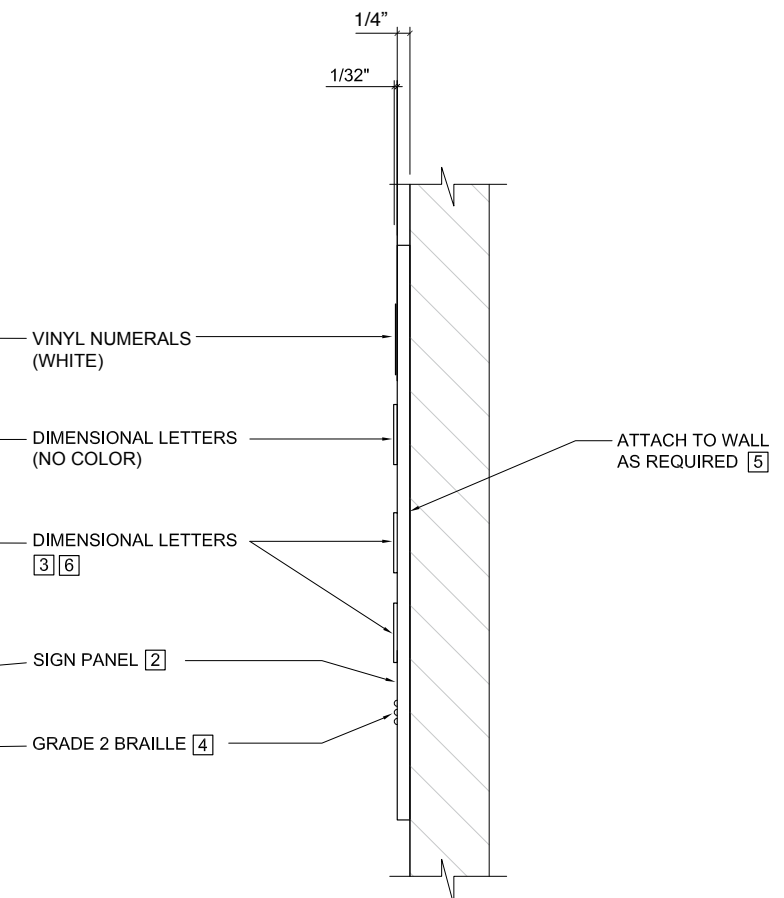

2 Side Elevation
NOT TO SCALE

Multiple Room Identity

R_2

Sign Type Design

GENERAL NOTES:

1. ADA COMPLIANT ROOM IDENTIFICATION SIGNAGE WITH REPLACEABLE NAME PANELS.
2. SIGN PANEL TO BE 1/4" THICK PHOTOPOLYMER MOUNTED TO 1/8" THICK ALUMINUM BACKGROUND PANEL.
3. BACKGROUND PANEL TO BE PAINTED ALUMINUM, PERMANENTLY ATTACHED TO SIGN PANEL AND REPLACEABLE PANEL EXTRUSION.
4. PHOTOPOLYMER DIMENSIONAL LETTERS TO BE MINIMUM 1/32" PROTRUSION FROM SIGN FACE AND SCREEN-TIPPED IN COLOR INDICATED.
5. PHOTOPOLYMER GRADE 2 BRAILLE TO BE ADA COMPLIANT WITH COLOR TO MATCH BACKGROUND COLOR.
6. PANEL GUIDES TO BE BRUSHED ALUMINUM REPLACEABLE PANEL EXTRUSION OR FABRICATED AS REQUIRED.
7. REPLACEABLE PANELS TO BE PAINTED ACRYLIC WITH VINYL COPY. PANELS TO BE HELD IN PLACE WITH HIDDEN FASTENERS.
8. SIGN TO BE MOUNTED TO WALL WITH THREADED WELDED STUDS AND SILICONE ADHESIVE AS REQUIRED.
9. SIGNAGE SHOWN IS FOR PLACEMENT PURPOSES ONLY. LAWA TO PROVIDE MESSAGE SCHEDULE FOR SPECIFIC MESSAGES PER LOCATION OF SIGNS.
10. 3/8" MINIMUM FOR BRAILLE HEIGHT.

NOTE:
CA-COMPLIANT GRADE 2 BRAILLE BY A CERTIFIED GRADE 2 BRAILLE TRANSLATOR.

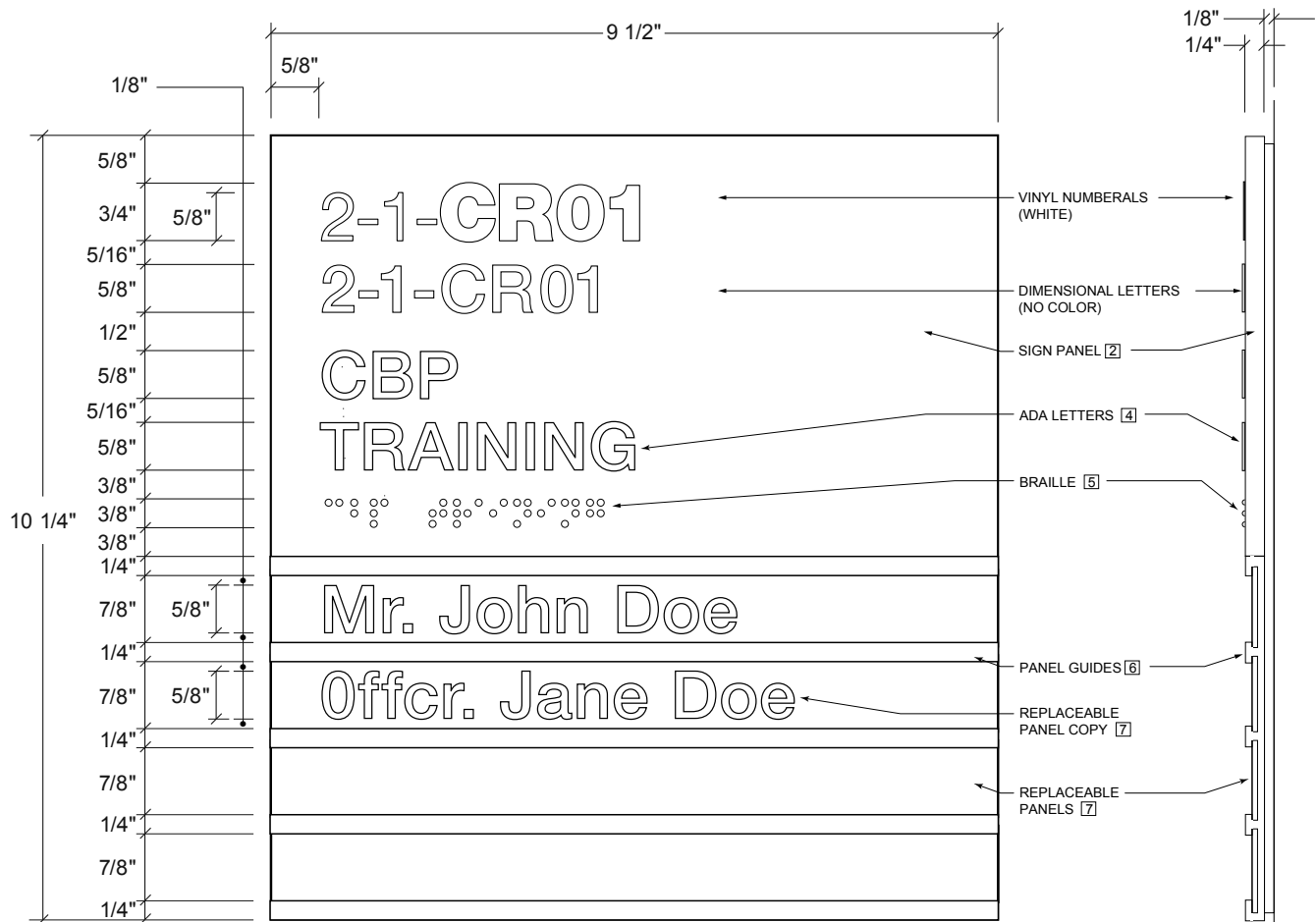

1 FRONT ELEVATION
NOT TO SCALE

2 SECTION DETAIL
NOT TO SCALE



Defibrillator Identity Blade

Sign Type Design

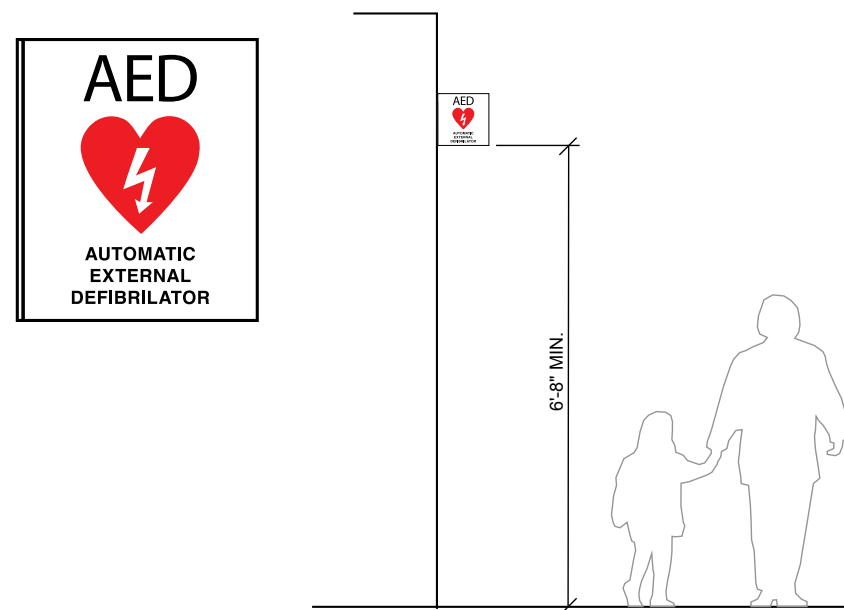

GENERAL NOTES:

1. DOUBLE-FACED, NON-ILLUMINATED WALL MOUNTED SIGN PANEL.
2. SIGN PANEL TO BE 1/4" THICK ALUMINUM WITH WHITE PAINTED FACE.
3. COPY AND PICTOGRAMS TO BE VINYL-DIE-CUT IN COLORS INDICATED.
4. FABRICATED ALUMINUM MOUNTING PLATE WITH BRUSHED FINISH.
5. ATTACH SIGN TO FACILITY WALL WITH STAINLESS STEEL COUNTERSUNK FASTENERS AS REQUIRED.
6. VERIFY EXISTING CONDITIONS PRIOR TO FABRICATION OF SIGN. COORDINATE WITH GENERAL CONTRACTOR TO PROVIDE ADDITIONAL BLOCKING AS REQUIRED.

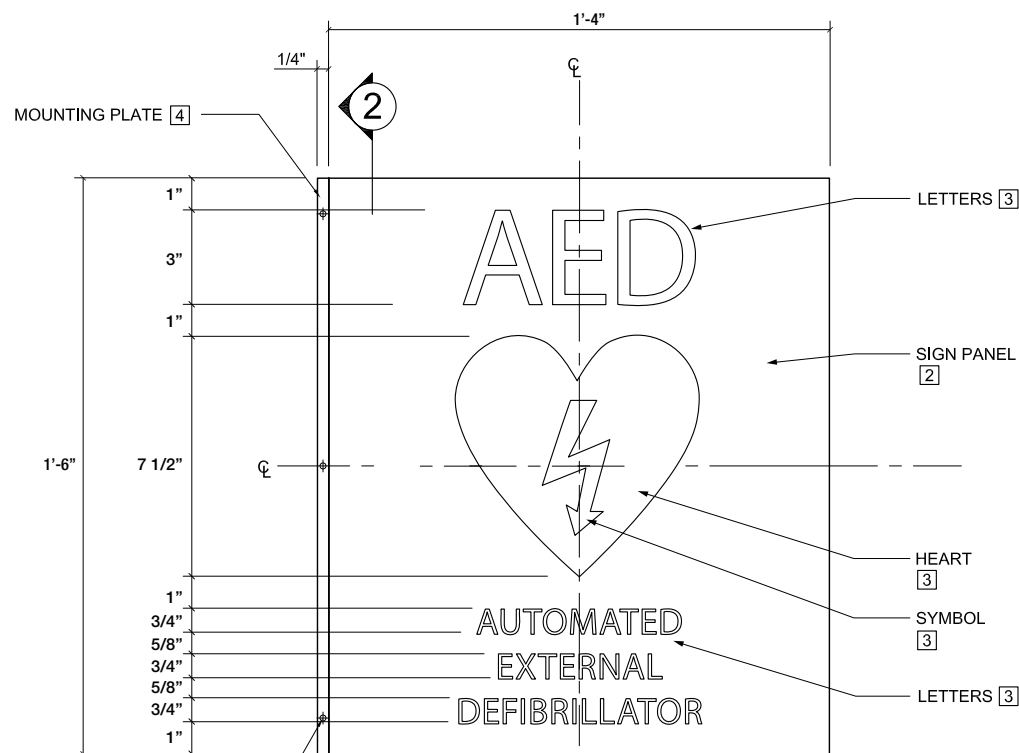

COUNTERSUNK FASTENERS AS REQUIRED. HEADS TO MATCH [5]

1 FRONT ELEVATION
NOT TO SCALE

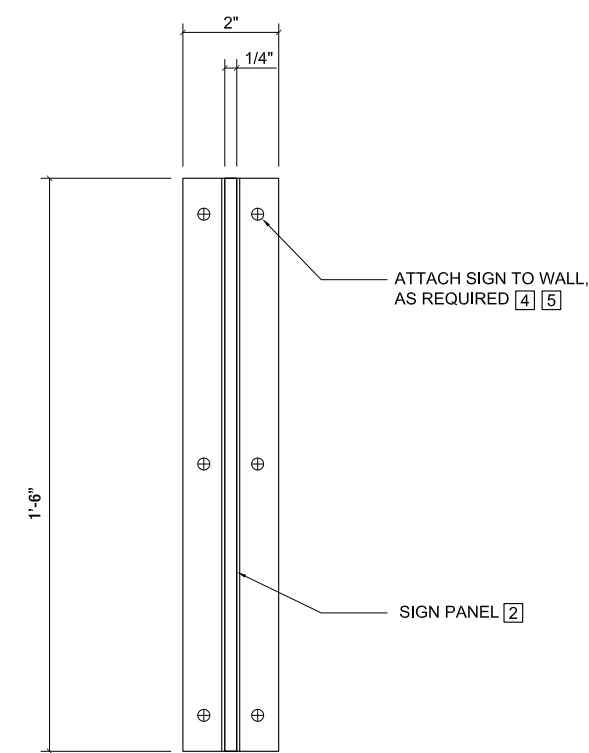

2 MOUNTING PLATE
NOT TO SCALE

GENERAL NOTES:

- 1 PRINTED DECAL ON WHITE BACKGROUND.
- 2 VERIFY WALL CONDITIONS / BINNACLE PRIOR TO FABRICATION OF SIGN

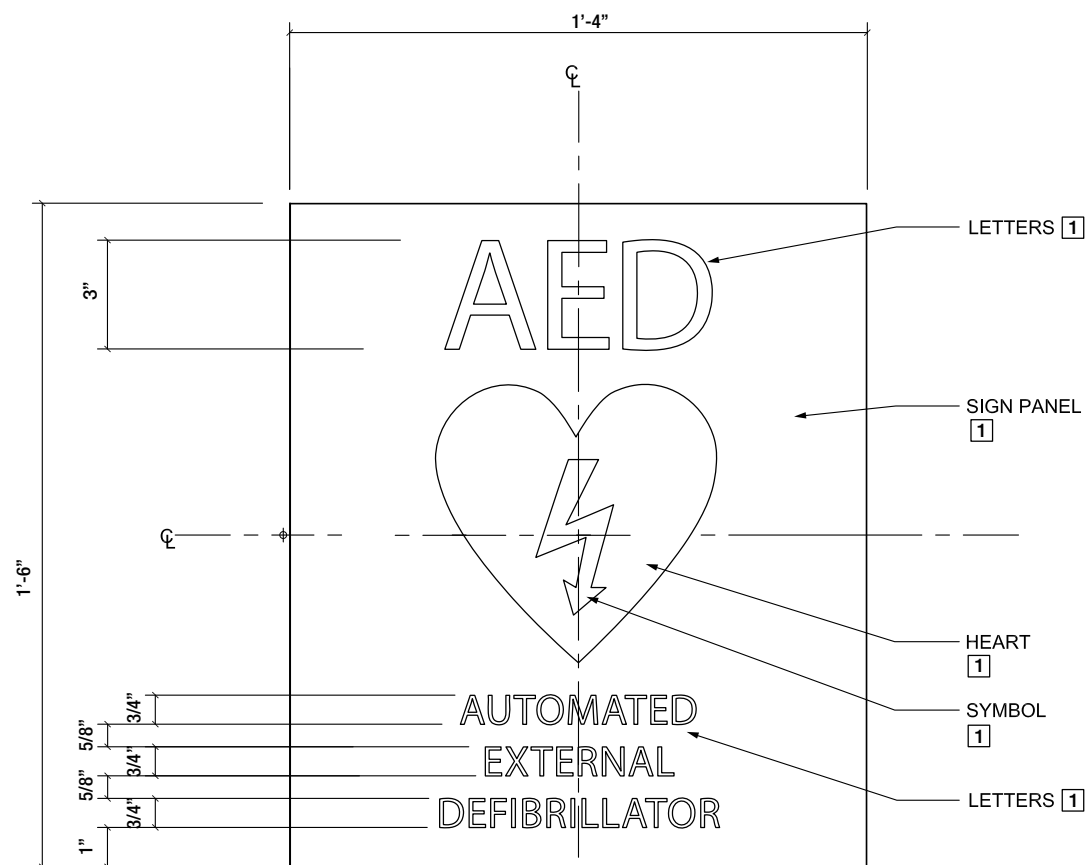

1 FRONT ELEVATION
NOT TO SCALE

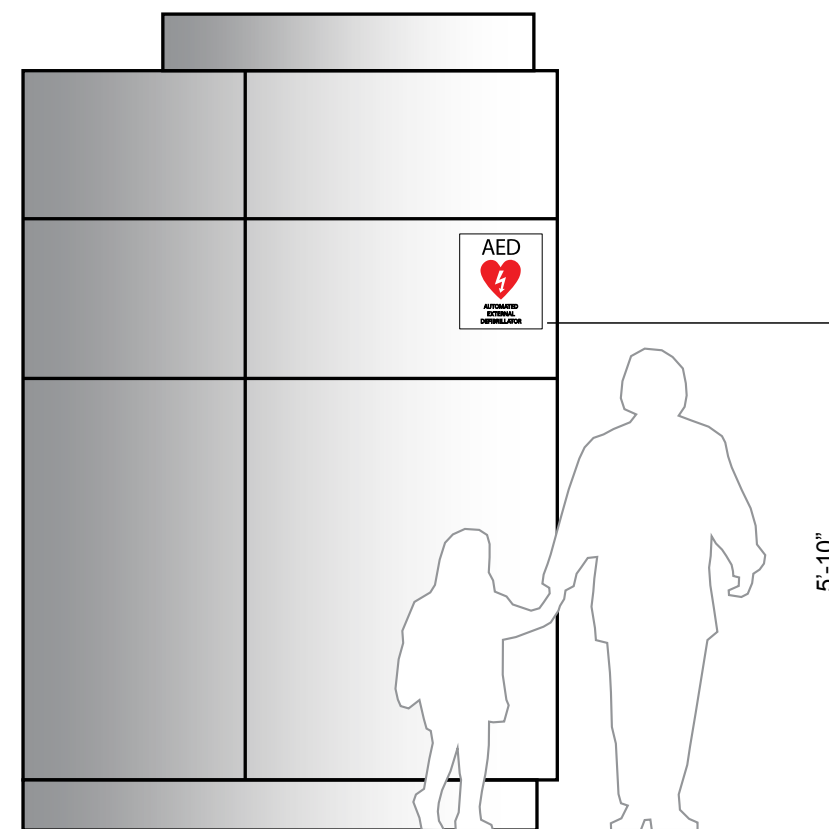
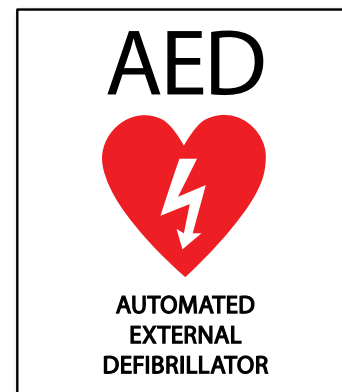

Sign Type Design

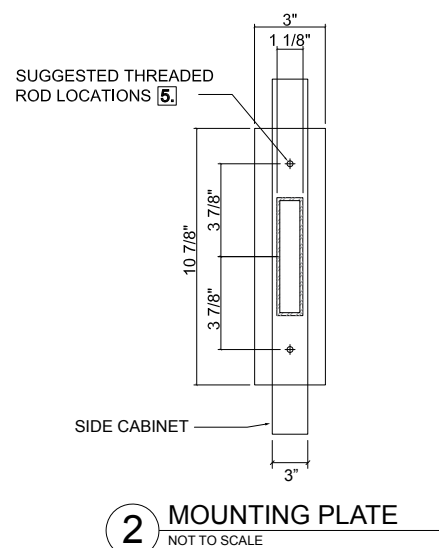
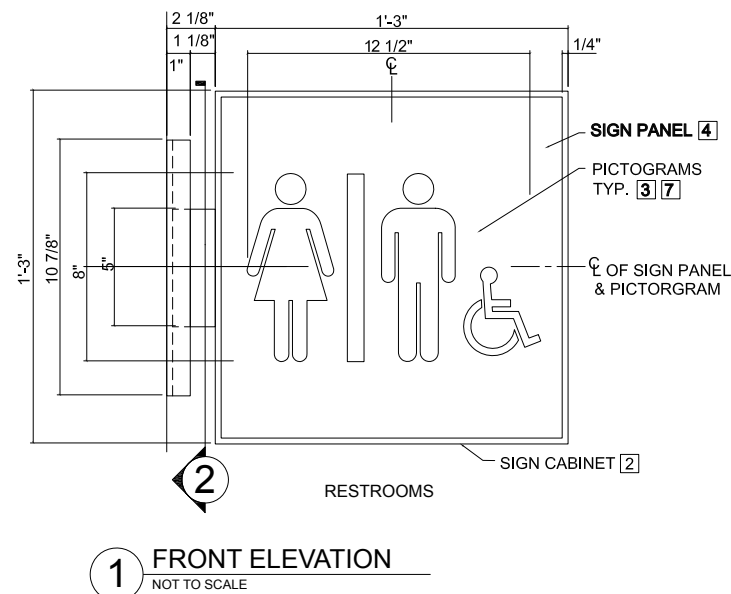
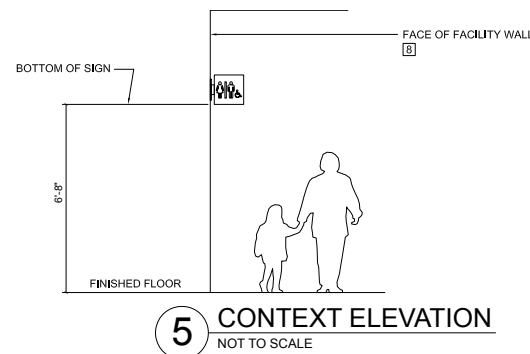

GENERAL NOTES:

1. DOUBLE-FACED, NON-ILLUMINATED, WALL MOUNTED BLADE SIGN.
2. FABRICATED ALUMINUM SIGN CABINET.
3. PICTOGRAMS TO BE FLAT-CUT OUT 1/4" THICK ALUMINUM PAINTED IN COLORS NOTED. PICTOGRAMS TO BE MOUNTED TO SIGN PANEL WITH HIDDEN MECHANICAL FASTENERS.
4. SIGN PANEL TO BE 1/4" THICK WITH FACE AND EDGES PAINTED IN COLOR AS NOTED.
5. DESIGNER TO FIELD VERIFY AND DETERMINE BEST METHOD OF INSTALLATION WITH MINIMAL VISUAL IMPACT. DESIGNER TO PROVIDE STRUCTURAL ENGINEERING CALCULATIONS AS REQUIRED AND COORDINATE WITH GENERAL CONTRACTOR FOR STRUCTURAL REQUIREMENTS.
6. ESTIMATED SIGN WEIGHT: 50 LBS EACH.
7. VERIFY SPECIFIC MESSAGE PER SIGN LOCATION WITH LAWA.

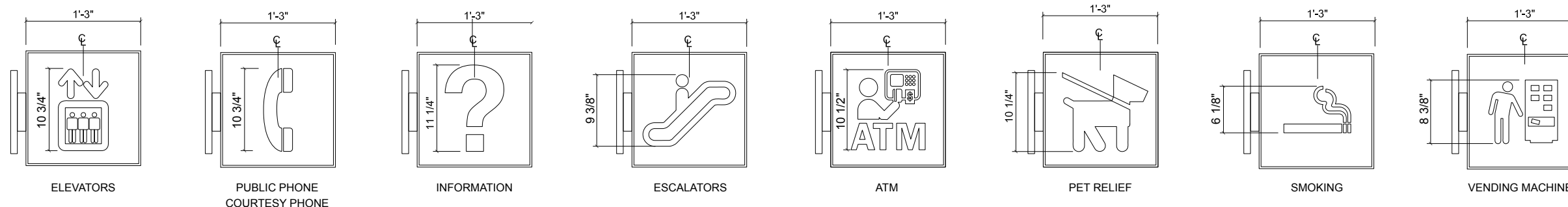
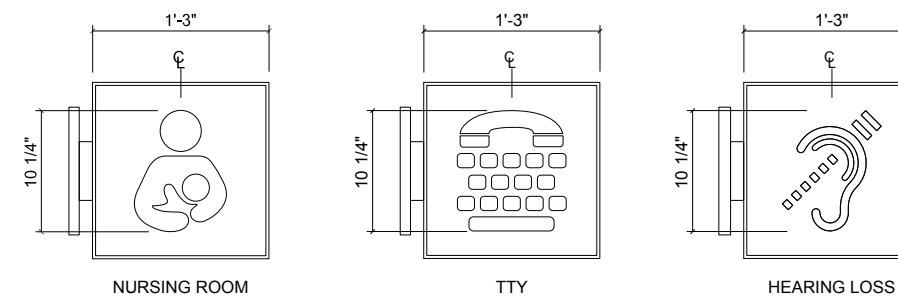
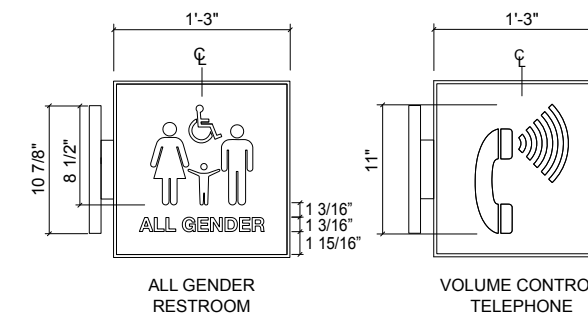

6 ADDITIONAL LAYOUTS

NOT TO SCALE

Restroom Identity Door

R_6

Sign Type Design

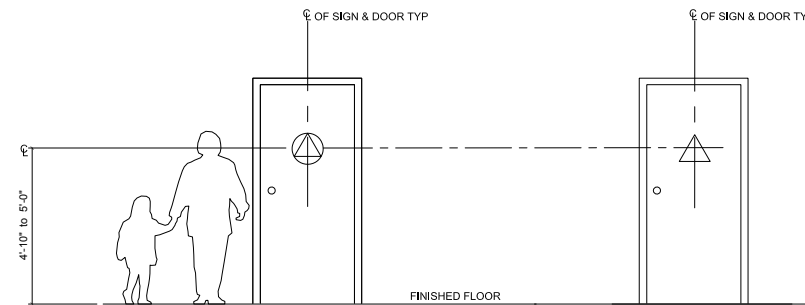

5 CONTEXT ELEVATION
NOT TO SCALE

GENERAL NOTES:

- 1 TITLE 24 REGULATORY RESTROOM IDENTITY SIGNAGE MOUNTED TO DOOR.
- 2 CIRCLE AND TRIANGLE SIGN PANELS TO BE 1/4" PHOTOPOLYMER WITH SILICONE ADHESIVS AND DOUBLE-SIDE TAPE.
- 3 BACKGROUND TO BE MASKED AND PAINTED IN COLOR AS INDICATED.
- 4 PICTOGRAMS TO BE SCREEN PRINTED IN COLOR AS INDICATED.
- 5 MOUNT TO DOOR WITH WELDED THREADED STUDS AND SILICONE ADHESIVE AS REQUIRED.
- 6 COORDINATE WITH LAWA FOR SPECIFIC LOCATIONS AND MESSAGES PER SIGN LOCATION.

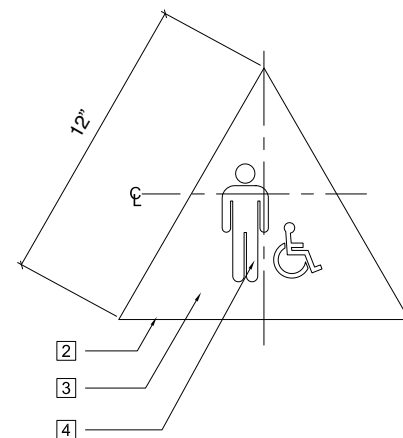

1 FRONT ELEVATION MEN
NOT TO SCALE

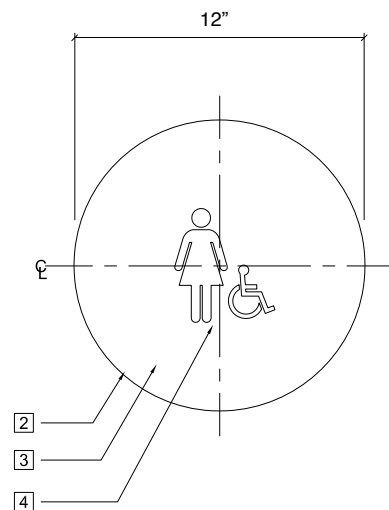

2 FRONT ELEVATION WOMEN
NOT TO SCALE

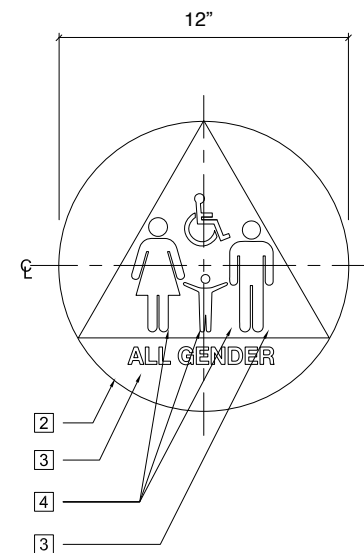

3 ALL GENDER
NOT TO SCALE

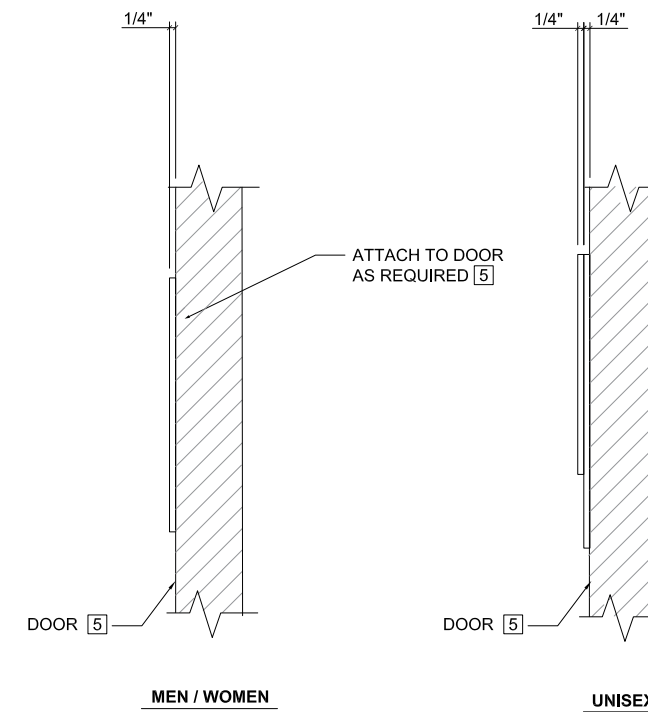

4 SIDE VIEWS
NOT TO SCALE

Restroom Identity Wall

Sign Type Design

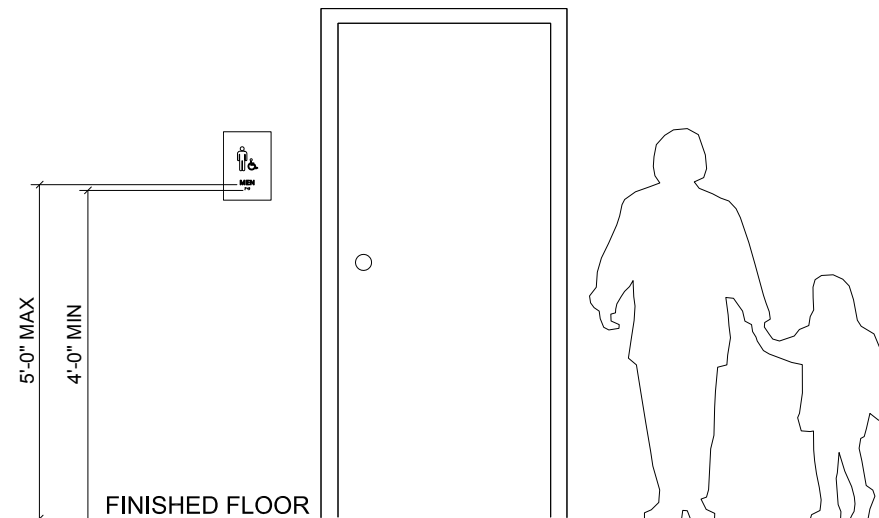

4 CONTEXT ELEVATION
NOT TO SCALE

GENERAL NOTES:

1. ADA COMPLIANT ROOM IDENTIFICATION SIGNAGE.
2. SIGN PANEL TO BE 1/8" THICK PHOTOPOLYMER. PAINT TO MATCH COLOR INDICATED.
3. PHOTOPOLYMER DIMENSIONAL LETTERS TO BE MINIMUM 1/32" PROTRUSION FROM SIGN FACE. LETTERS TO BE SCREEN-TIPPED IN COLOR INDICATED.
4. PHOTOPOLYMER CA-COMPLIANT GRADE 2 BRAILLE BY A CERTIFIED GRADE 2 BRAILLE TRANSLATOR WITH COLOR TO MATCH BACKGROUND COLOR.
5. SIGN TO BE MOUNTED TO WALL WITH THREADED WELDED STUDS AND SILICONE ADHESIVE AS REQUIRED.
6. COORDINATE WITH LAWA FOR SPECIFIC LOCATIONS AND MESSAGES PER SIGN LOCATION.

NOTE:
SIGN MOUNTING HEIGHT IS NOT SHOWN OR NOTED. AS WITH ALL ROOM IDENTIFICATION SIGNAGE, THESE SIGNS ARE REQUIRED TO BE MOUNTED NO LOWER THAN 48" AFF MEASURED TO THE BASELINE OF THE LOWEST LINE OF BRAILLE CELLS, AND NO HIGHER THAN 60" AFF MEASURED TO THE BASELINE OF THE HIGHEST LINE OF RAISED CHARACTERS. (CBC 11B-703.4.1).

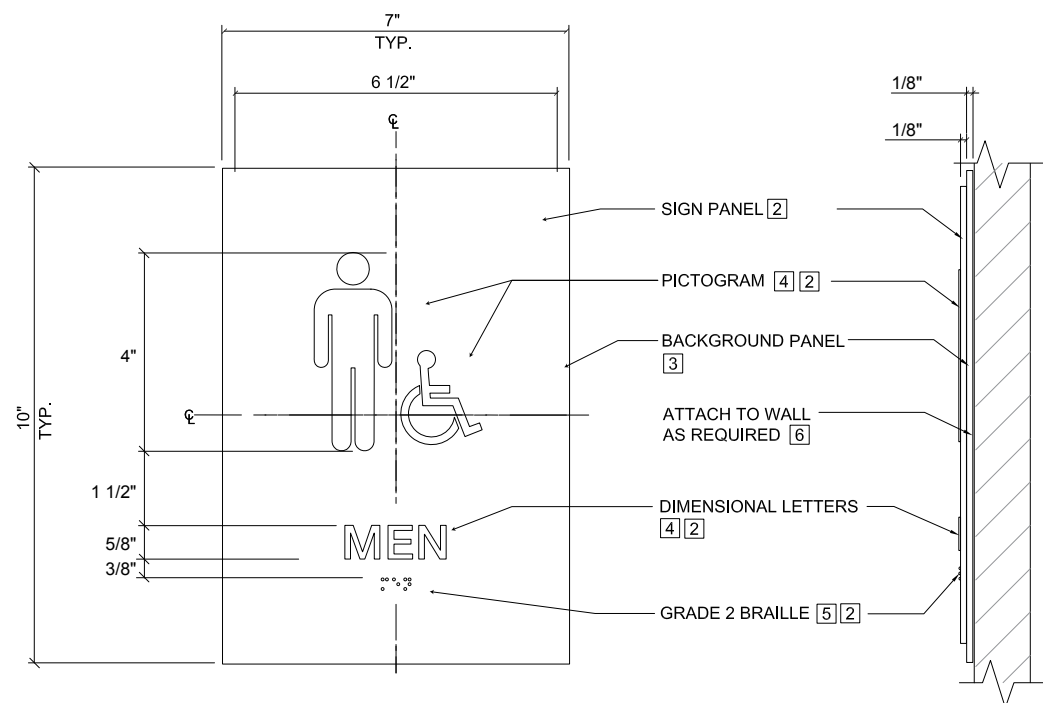

1 FRONT ELEVATION
NOT TO SCALE

2 SIDE ELEVATION
NOT TO SCALE

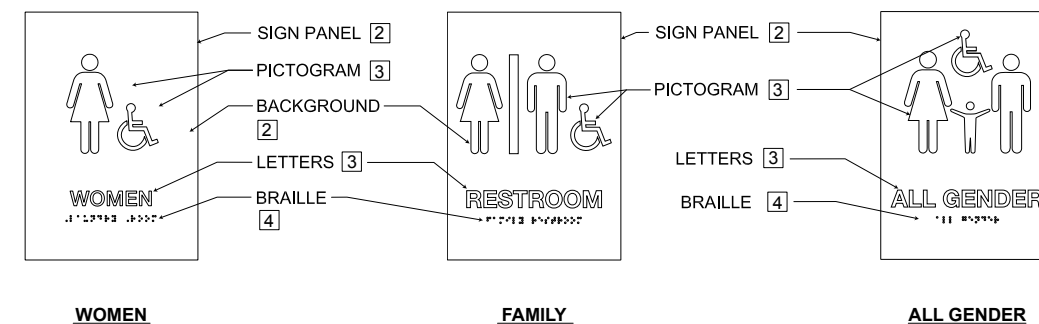

3 ADDITIONAL LAYOUTS
NOT TO SCALE

Restroom Identity No Door



GENERAL NOTES:

1. ADA/TITLE 24 COMPLIANT ROOM IDENTIFICATION SIGNAGE.
- 2 SIGN PANEL TO BE 1/4" THICK PHOTOPOLYMER WITH PAINTED EDGE AND BORDER. UNISEX VERSION TO BE PERMANENTLY MOUNTED TO BACKGROUND PANEL.
- 3 BACKGROUND PANEL FOR UNISEX VERSION ONLY TO BE PHOTOPOLYMER. PAINT TO MATCH COLORS INDICATED.
- 4 PICTOGRAMS/LETTERS TO BE SCREEN PRINTED IN COLOR INDICATED.
- 5 SIGN TO BE MOUNTED TO WALL WITH THREADED WELDED STUDS AND SILICONE ADHESIVE AS REQUIRED.
- 6 COORDINATE WITH LAWA FOR SPECIFIC LOCATIONS AND MESSAGES PER SIGN LOCATION.

NOTE:
RAISED LETTERS AND BRAILLE ARE NOT REQUIRED, NOR SHOULD IT BE PROVIDED ON THESE SIGNS, ESPECIALLY IF MOUNTED ON SWINGING DOORS.

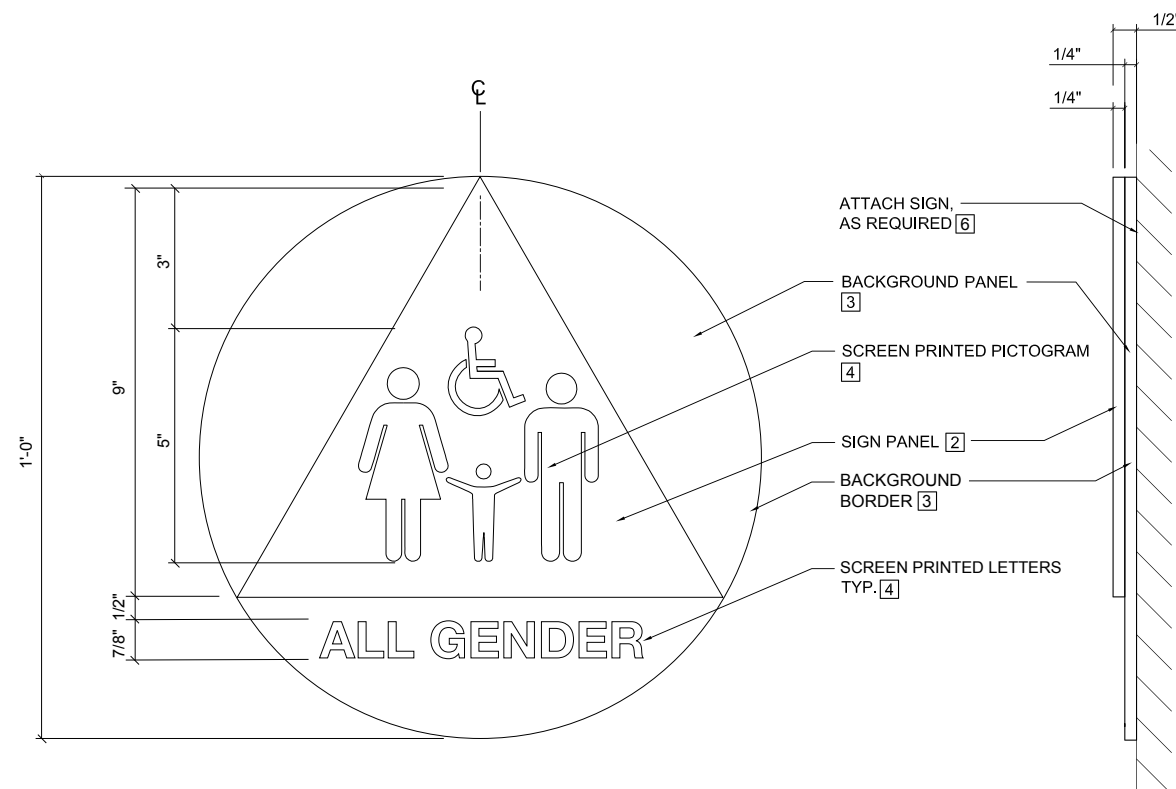

1 FRONT ELEVATION - ALL GENDER
NOT TO SCALE

2 SIDE VIEW - ALL GENDER
NOT TO SCALE

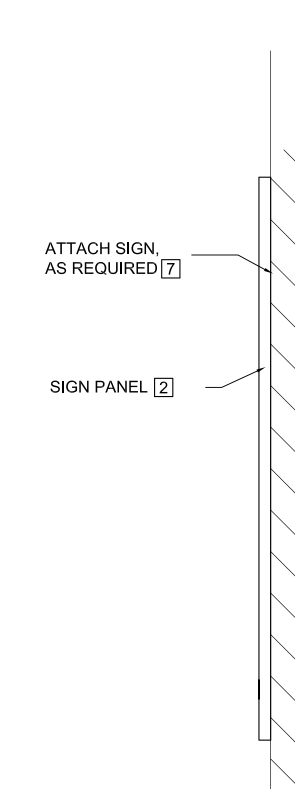

3 SIDE VIEW - MEN/WOMEN
NOT TO SCALE

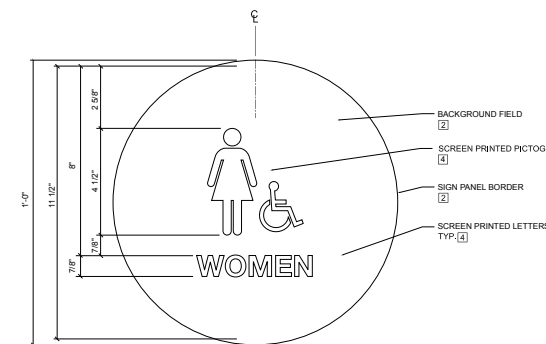

4 FRONT VIEW - MEN/WOMEN
NOT TO SCALE

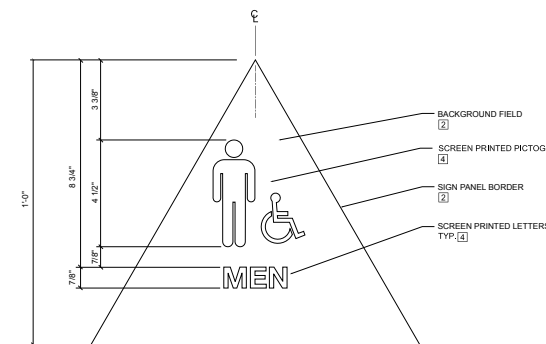

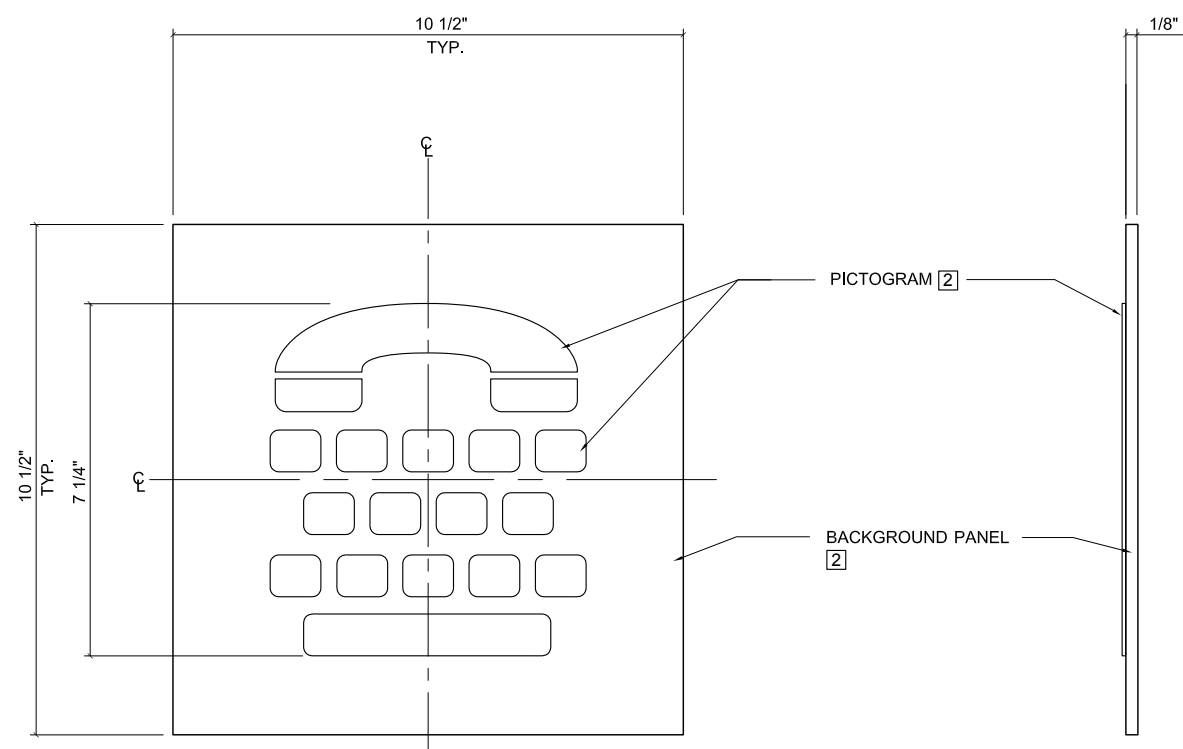

1 FRONT ELEVATION
NOT TO SCALE

2 SIDE VIEW
NOT TO SCALE

GENERAL NOTES:

1. WALL MOUNTED IDENTIFICATION SIGNAGE.
2. SIGN PANEL TO BE 1/8" THICK PHOTOPOLYMER. PAINT TO MATCH COLOR INDICATED.
3. SIGN TO BE MOUNTED TO WALL WITH VHB TAPE AND SILICONE ADHESIVE AS REQUIRED.
4. COORDINATE WITH LAWA FOR SPECIFIC LOCATIONS AND MESSAGES PER SIGN LOCATION.

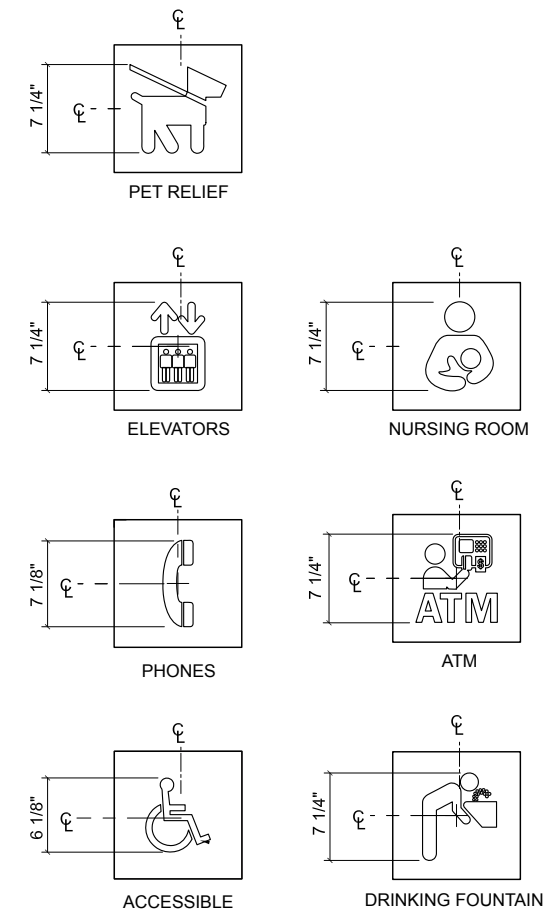

4 ADDITIONAL LAYOUTS
NOT TO SCALE



- GENERAL NOTES:
1. WALL MOUNTED IDENTIFICATION SIGNAGE.
 2. SIGN PANEL TO BE 1/8" THICK PHOTOPOLYMER. PAINT TO MATCH COLOR INDICATED.
 3. SIGN TO BE MOUNTED TO DOOR WITH VHB TAPE AND SILICONE ADHESIVE AS REQUIRED.
 4. COORDINATE WITH LAWA FOR SPECIFIC LOCATIONS.

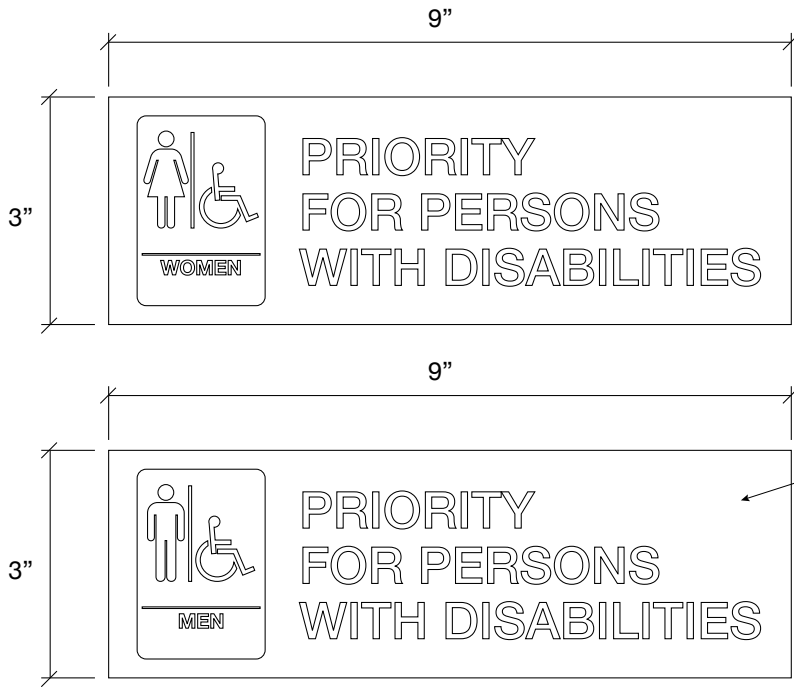

1 FRONT ELEVATION
NOT TO SCALE

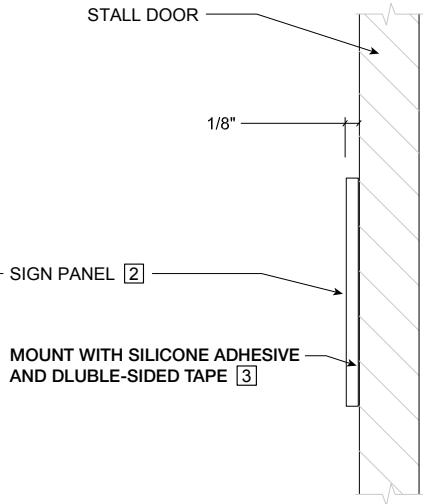

2 SIDE ELEVATION
NOT TO SCALE

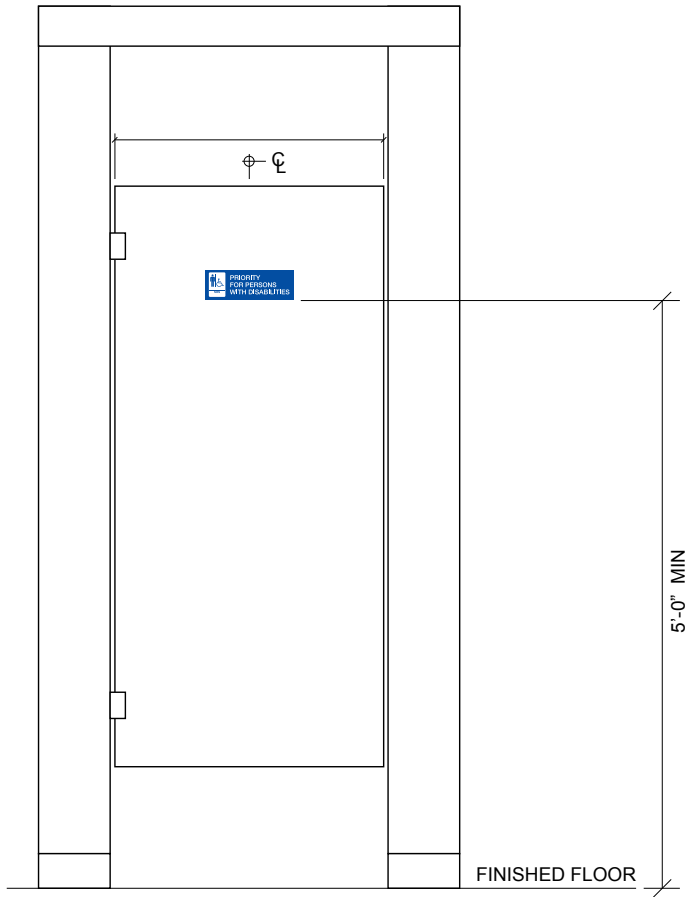

3 CONTEXT ELEVATION
NOT TO SCALE

Sign Type Design



GENERAL NOTES:

- 1 DOUBLE-FACED, NON-ILLUMINATED, CEILING MOUNTED SIGN CABINET.
- 2 FABRICATED SIGN CABINET WITH INTERNAL FRAMING AS REQUIRED.
- 3 SIGN PANEL TO BE 3/4" DEEP FABRICATED ALUMINUM WITH PAINT FINISH AS NOTED.
- 4 COPY AND GRAPHICS TO BE VINYL DIE CUT IN COLORS INDICATED ON DRAWING.
- 5 PRIOR TO BID SUBMISSION, FIELD VERIFY EXISTING CONDITIONS PRIOR TO FABRICATION OF SIGN. DETERMINE BEST METHOD FOR SIGNAGE INSTALLATION. PROVIDE STRUCTURAL ENGINEERING CALCULATIONS.
- 6 COORDINATE WITH GENERAL CONTRACTOR TO PROVIDE ADDITIONAL SIGNAGE SUPPORT AS REQUIRED.
- 7 VERTICAL SUPPORTS WITH DECORATIVE CLADDING AS REQUIRED. PROVIDE SMALLEST DIAMETER AS ALLOWED BY STRUCTURAL ENGINEERING CALCULATIONS.
- 8 SIGNAGE SHOWN IS FOR PLACEMENT PURPOSES ONLY. FINAL MESSAGE AND LOCATION OF SIGN TO BE PROVIDED BY LAWA.
- 9 THE SCALE OF THE SIGNAGE AND GRAPHICS ARE SUBJECT TO CHANGE IN ORDER TO BE COMPLIANT WITH ADA GUIDELINES IF THE INSTALLATION SITE EXCEEDS THE HEIGHT SHOWN IN THE DRAWING PROVIDED.

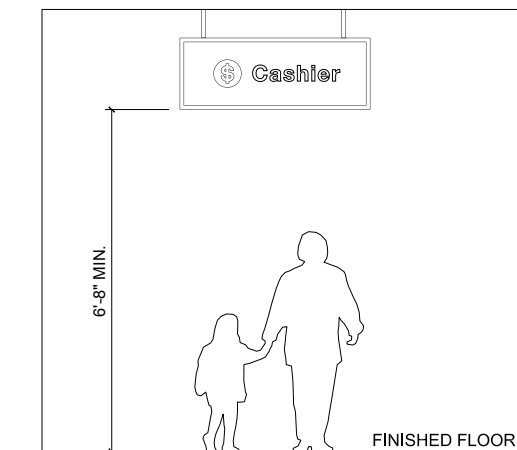
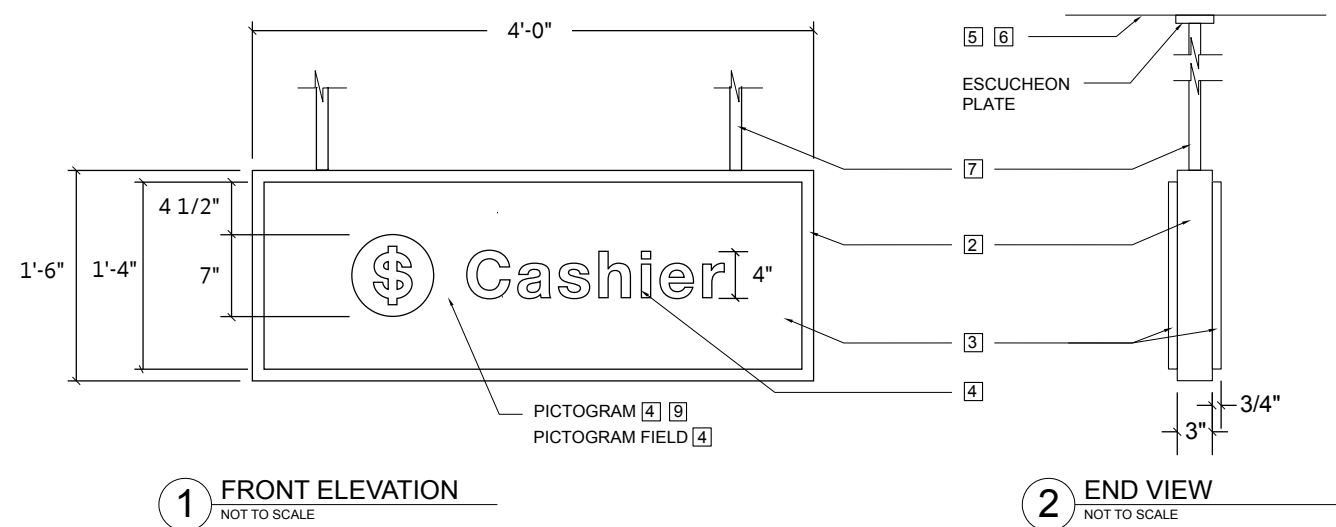

Pedestrian Directional – Smaller Overhead

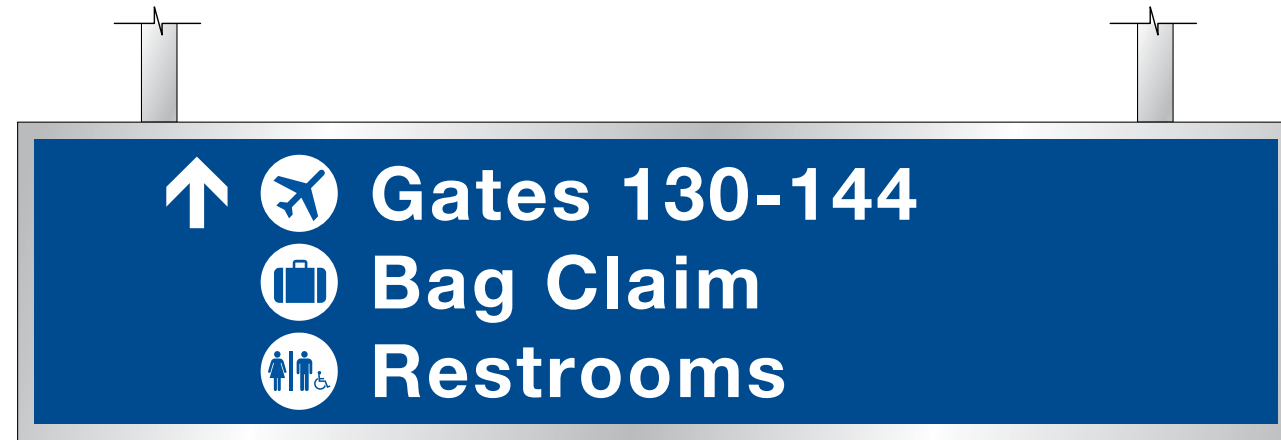

GENERAL NOTES:

1. DOUBLE-FACED, NON-ILLUMINATED, CEILING MOUNTED SIGN CABINET.
2. FABRICATED SIGN CABINET WITH INTERNAL FRAMING AS REQUIRED.
3. SIGN PANEL TO BE 3/4" DEEP FABRICATED ALUMINUM WITH PAINT FINISH AS NOTED.
4. COPY AND GRAPHICS TO BE VINYL DIE CUT IN COLORS INDICATED ON DRAWING.
5. PRIOR TO BID SUBMISSION, FIELD VERIFY EXISTING CONDITIONS PRIOR TO FABRICATION OF SIGN. DETERMINE BEST METHOD FOR SIGNAGE INSTALLATION WITH CONCEALED MECHANICAL FASTENERS. PROVIDE STRUCTURAL ENGINEERING CALCULATIONS.

NOTE:

THE SCALE OF THE SIGNAGE AND GRAPHICS ARE SUBJECT TO CHANGE IN ORDER TO BE COMPLIANT WITH ADA GUIDELINES IF THE INSTALLATION SITE EXCEEDS THE HEIGHT SHOWN IN THE DRAWING PROVIDED.

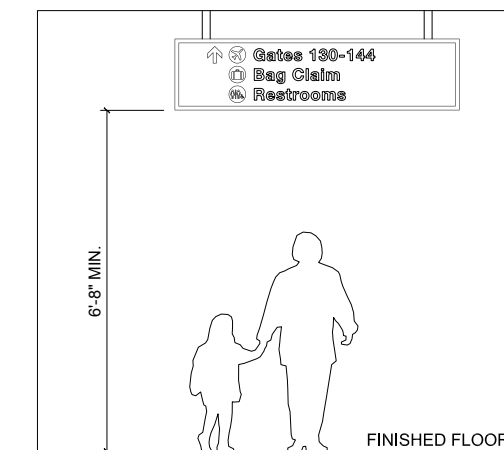
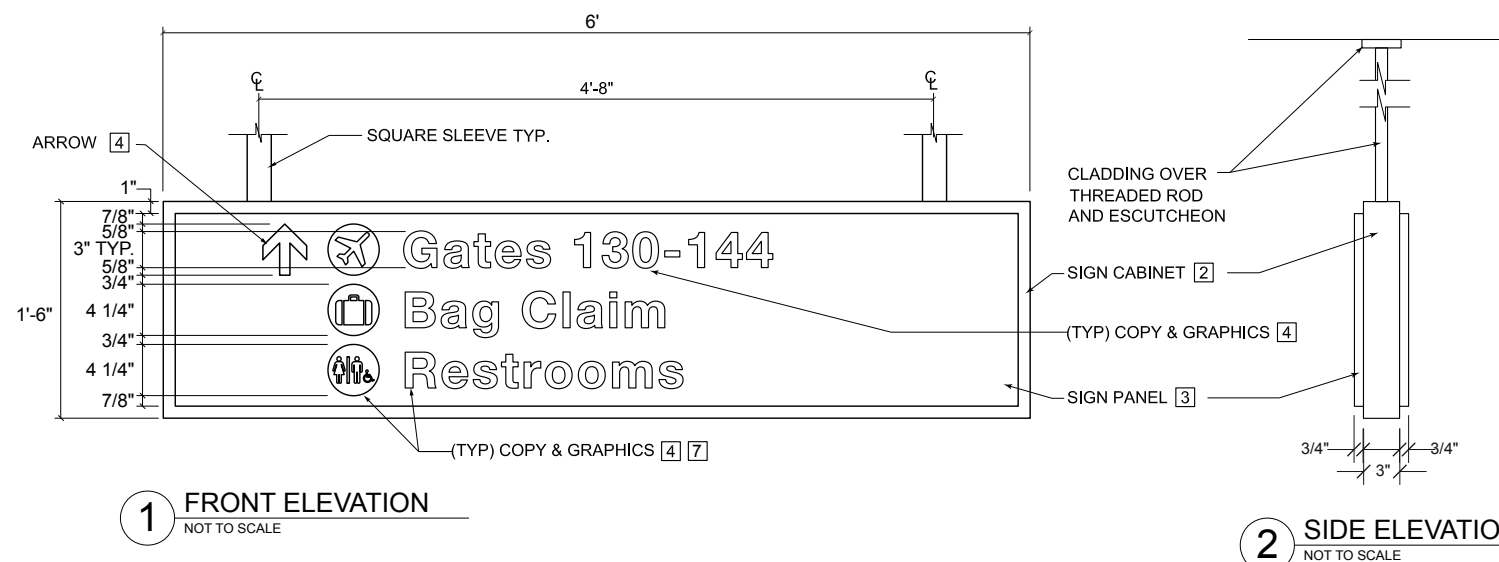

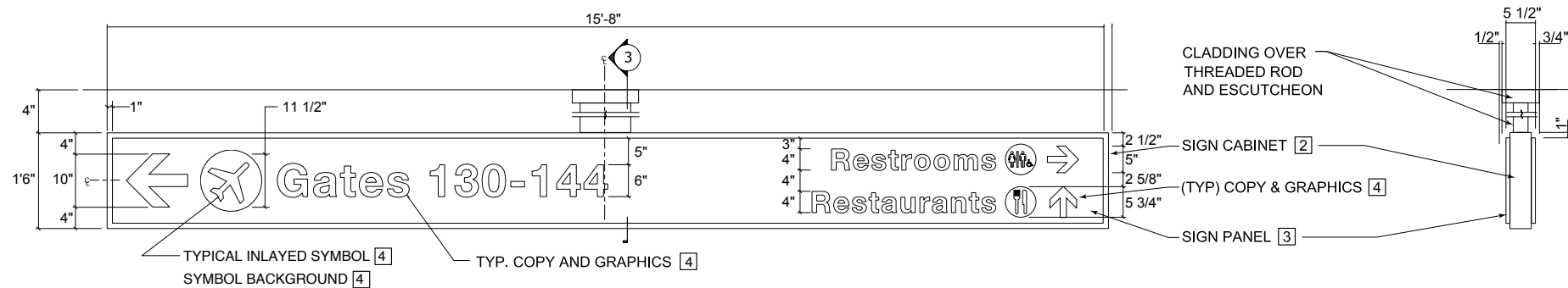
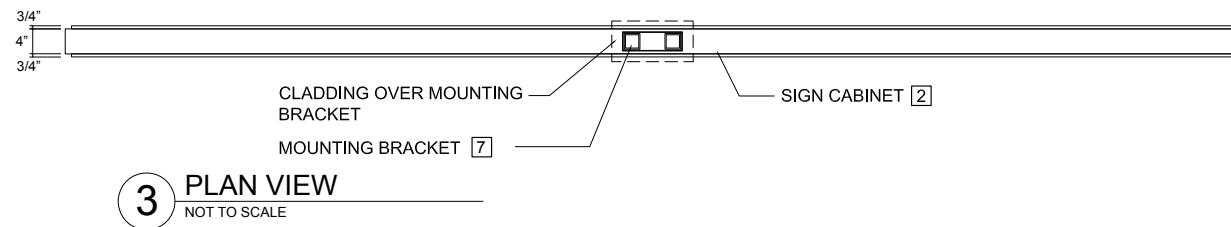
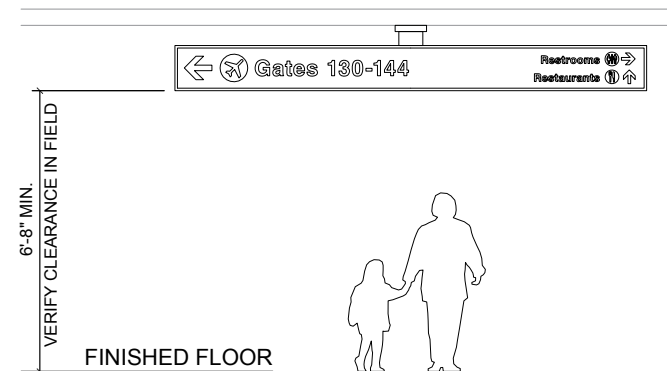

GENERAL NOTES:

1. DOUBLE-FACED, NON-ILLUMINATED, CEILING MOUNTED SIGN CABINET.
2. FABRICATED SIGN CABINET WITH INTERNAL FRAMING AS REQUIRED.
3. SIGN PANEL TO BE 3/4" DEEP FABRICATED ALUMINUM WITH PAINT FINISH AS NOTED.
4. COPY AND GRAPHICS TO BE VINYL DIE CUT IN COLORS INDICATED ON DRAWING.
5. DESIGNER TO FIELD VERIFY AND DETERMINE BEST METHOD OF INSTALLATION WITH MINIMAL VISUAL IMPACT. DESIGNER TO PROVIDE STRUCTURAL ENGINEERING CALCULATIONS AS REQUIRED AND COORDINATE WITH GENERAL CONTRACTOR FOR STRUCTURAL REQUIREMENTS.
6. FIELD VERIFY EXISTING CONDITIONS PRIOR TO BID SUBMISSION.
7. VERTICAL SUPPORTS WITH DECORATIVE CLADDING AS REQUIRED. PROVIDE SMALLEST DIAMETER AS ALLOWED BY STRUCTURAL ENGINEERING CALCULATIONS.
8. SIGNAGE SHOWN IS FOR PLACEMENT PURPOSES ONLY. FINAL MESSAGE AND LOCATION OF SIGN TO BE PROVIDED BY LAWA.

NOTE:

THE SCALE OF THE SIGNAGE AND GRAPHICS ARE SUBJECT TO CHANGE IN ORDER TO BE COMPLIANT WITH ADA GUIDELINES IF THE INSTALLATION SITE EXCEEDS THE HEIGHT SHOWN IN THE DRAWING PROVIDED.



CBP Directional Static/Dynamic Overhead

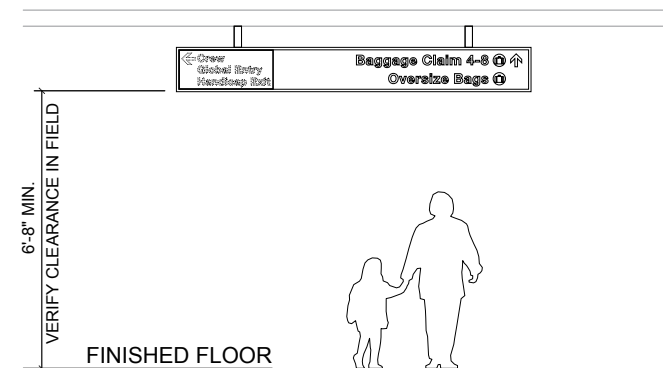

GENERAL NOTES:

1. DOUBLE-FACED, NON-ILLUMINATED, CEILING MOUNTED SIGN CABINET WITH LED DISPLAYS.
2. FABRICATED SIGN CABINET WITH INTERNAL FRAMING AS REQUIRED.
3. SIGN PANEL TO BE 3/4" DEEP FABRICATED ALUMINUM WITH PAINT FINISH AS NOTED.
4. COPY AND GRAPHICS TO BE VINYL DIE CUT IN COLORS INDICATED ON DRAWING.
5. LED DISPLAY TO BE PROVIDED BY LAWA. PROVIDE MANUFACTURER'S REQUIREMENTS FOR VENTILATION IN SIGN CABINET. ALLOW FOR EASE OF MAINTENANCE WITH INCONSPICUOUS ACCESS PANELS.
6. DESIGNER TO FIELD VERIFY AND DETERMINE BEST METHOD OF INSTALLATION WITH MINIMAL VISUAL IMPACT. DESIGNER TO PROVIDE STRUCTURAL ENGINEERING CALCULATIONS AS REQUIRED AND COORDINATE WITH GENERAL CONTRACTOR FOR STRUCTURAL REQUIREMENTS.
7. FIELD VERIFY EXISTING CONDITIONS PRIOR TO BID SUBMISSION.
8. VERTICAL SUPPORTS AND BRACKET WITH DECORATIVE CLADDING AS REQUIRED. PROVIDE SMALLEST DIAMETER AS ALLOWED BY STRUCTURAL ENGINEERING CALCULATIONS.
9. SIGNAGE SHOWN IS FOR PLACEMENT PURPOSES ONLY. FINAL MESSAGE AND LOCATION OF SIGN TO BE PROVIDED BY LAWA.

NOTE:

THE SCALE OF THE SIGNAGE AND GRAPHICS ARE SUBJECT TO CHANGE IN ORDER TO BE COMPLIANT WITH ADA GUIDELINES IF THE INSTALLATION SITE EXCEEDS THE HEIGHT SHOWN IN THE DRAWING PROVIDED.

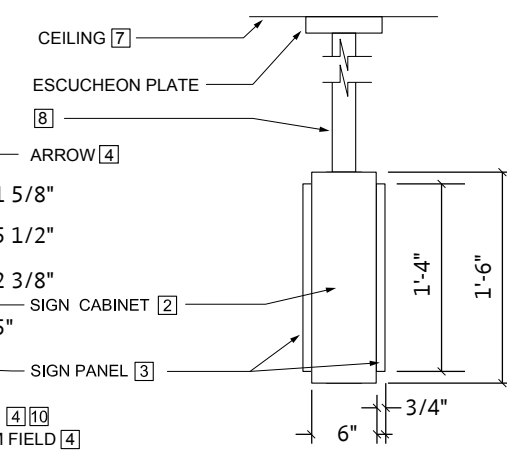
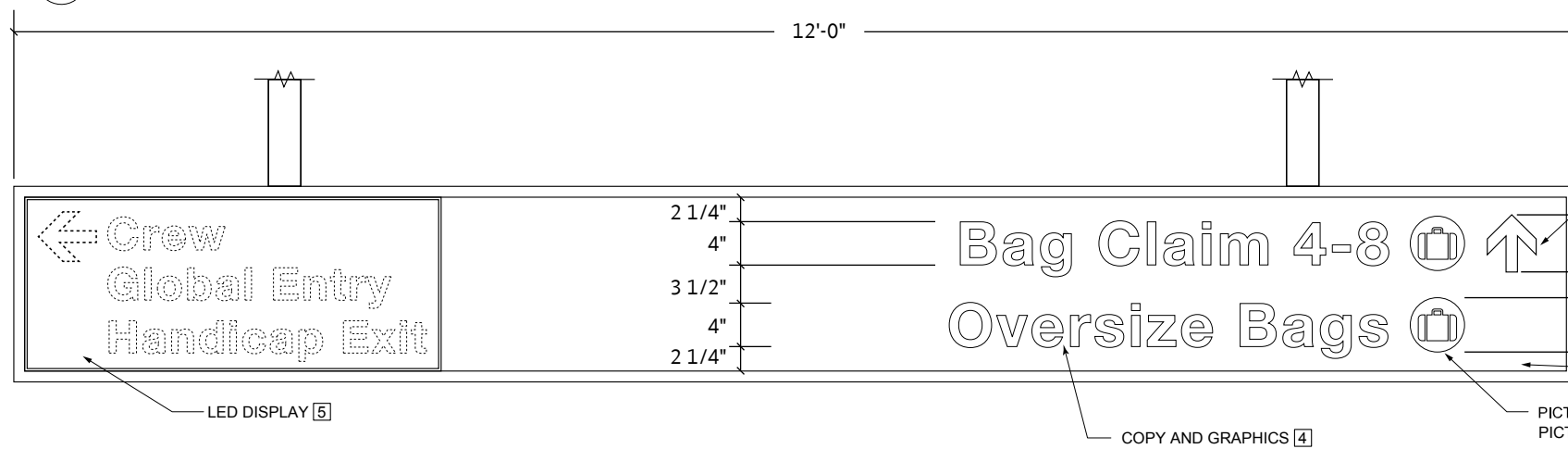
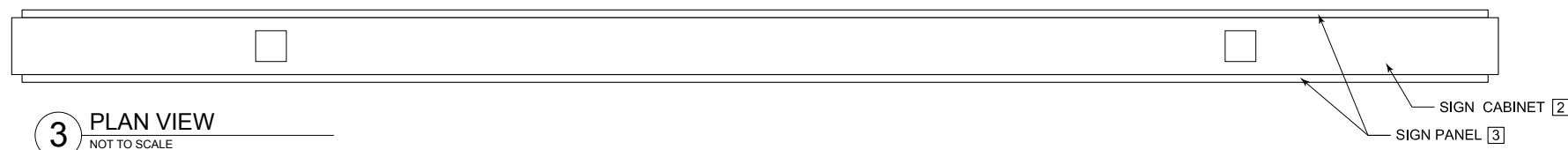

1 FRONT ELEVATION (SIDE A)
NOT TO SCALE

2 END ELEVATION
NOT TO SCALE

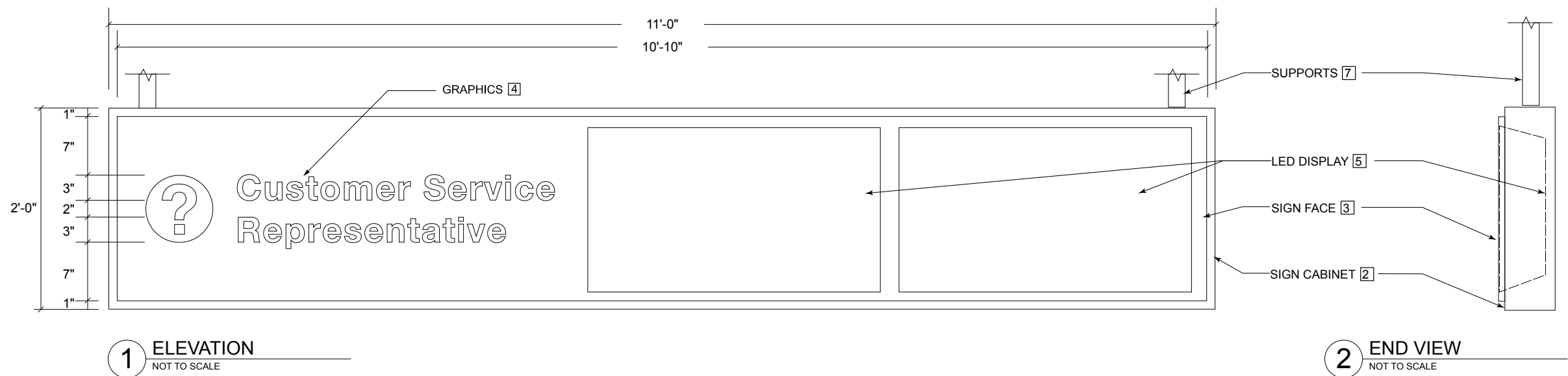
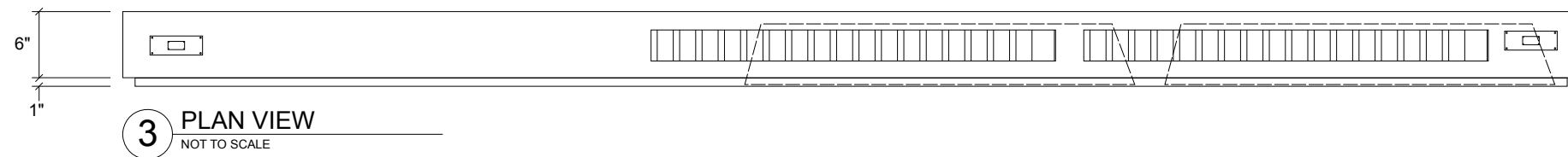
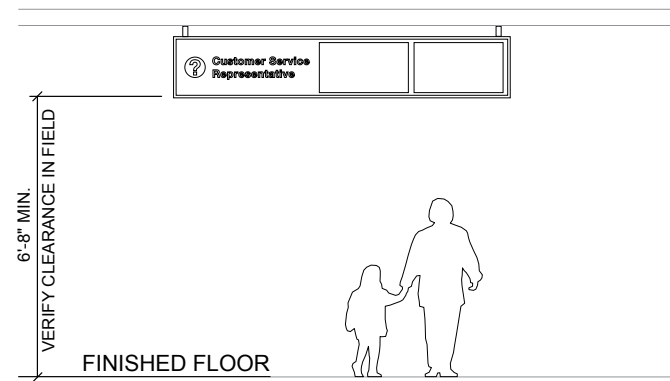

GENERAL NOTES:

1. SINGLE-FACED, NON-ILLUMINATED, CEILING MOUNTED SIGN CABINET WITH LED DISPLAYS.
2. FABRICATED SIGN CABINET WITH INTERNAL FRAMING AS REQUIRED.
3. SIGN PANEL TO BE 3/4" DEEP FABRICATED ALUMINUM. FACE AND RETURNS TO BE PAINTED IN COLOR AS NOTED.
4. COPY AND GRAPHICS TO BE VINYL DIE CUT IN COLORS INDICATED ON DRAWING.
5. LED DISPLAY SPECIFICATIONS TO BE APPROVED BY LAWA. PROVIDE MANUFACTURER'S REQUIREMENTS FOR VENTILATION IN SIGN CABINET. ALLOW FOR EASE OF MAINTENANCE WITH INCONSPICUOUS ACCESS PANELS.
6. DESIGNER TO FIELD VERIFY AND DETERMINE BEST METHOD OF INSTALLATION WITH MINIMAL VISUAL IMPACT. DESIGNER TO PROVIDE STRUCTURAL ENGINEERING CALCULATIONS AS REQUIRED AND COORDINATE WITH GENERAL CONTRACTOR FOR STRUCTURAL REQUIREMENTS.
7. VERTICAL SUPPORTS AND BRACKET WITH DECORATIVE CLADDING AS REQUIRED. PROVIDE SMALLEST DIAMETER AS ALLOWED BY STRUCTURAL ENGINEERING CALCULATIONS.
8. SIGNAGE SHOWN IS FOR PLACEMENT PURPOSES ONLY. FINAL MESSAGE AND LOCATION OF SIGN TO BE PROVIDED BY LAWA.

NOTE:
 THE SCALE OF THE SIGNAGE AND GRAPHICS ARE SUBJECT TO CHANGE IN ORDER TO BE COMPLIANT WITH ADA GUIDELINES IF THE INSTALLATION SITE EXCEEDS THE HEIGHT SHOWN IN THE DRAWING PROVIDED.



- GENERAL NOTES:
1. NON-ILLUMINATED, WALL MOUNTED FABRICATED ALUMINUM SIGN CABINET.
 2. ALUMINUM SIGN CABINET TO BE FABRICATED IN A MANNER TO ALLOW EASE OF MAINTENANCE. PROVIDE INTERNAL SUPPORT AS REQUIRED.
 3. SIGN FACE TO BE PAINTED ALUMINUM ATTACHED TO SIGN CABINET WITH BLIND FASTENERS.
 4. COPY AND GRAPHICS TO BE VINYL DIE-CUT IN COLOR INDICATED ON DRAWING.
 5. VERIFY EXISTING CONDITIONS PRIOR TO FABRICATION OF SIGN. COORDINATE WITH GENERAL CONTRACTOR TO PROVIDE ADDITIONAL BLOCKING AS REQUIRED. CONNECTION DETAILS AND STRUCTURAL CALCULATIONS TO BE VERIFIED BY STRUCTURAL ENGINEERING CALCULATIONS.
 6. VERIFY FINAL MESSAGE AND LOCATION OF SIGN WITH LAWA.

NOTE:
 THE SCALE OF THE SIGNAGE AND GRAPHICS ARE SUBJECT TO CHANGE IN ORDER TO BE COMPLIANT WITH ADA GUIDELINES IF THE INSTALLATION SITE EXCEEDS THE HEIGHT SHOWN IN THE DRAWING PROVIDED.

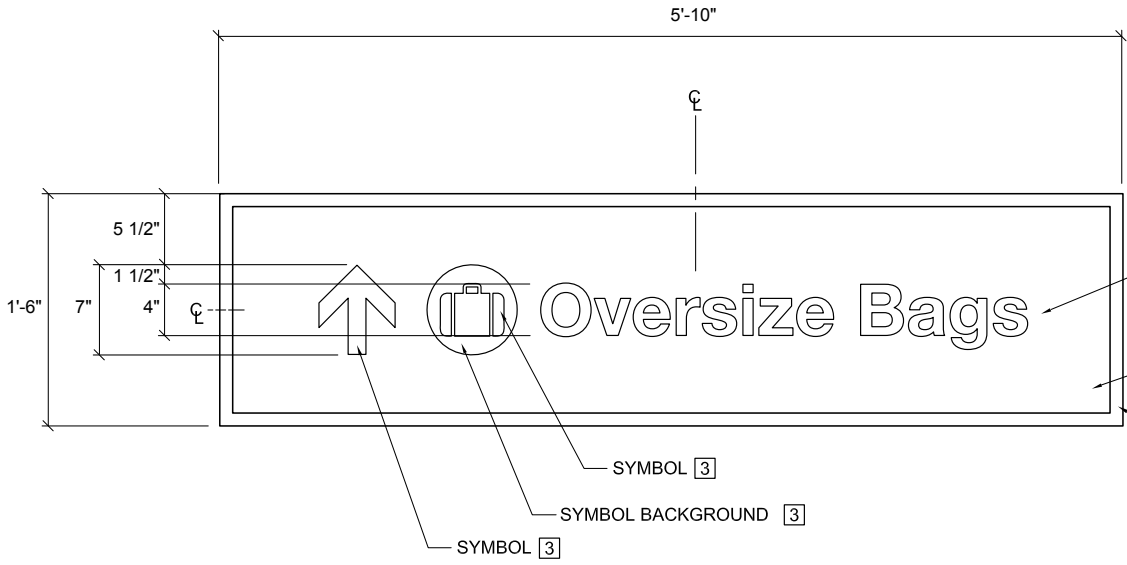
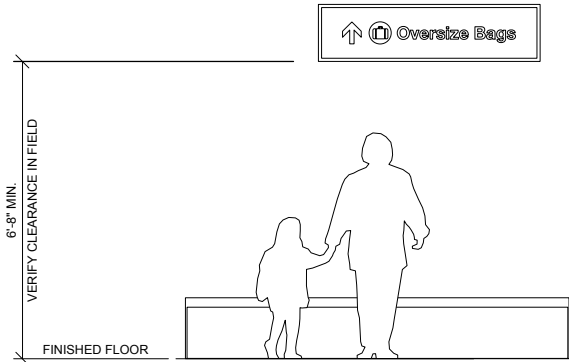

1 FRONT ELEVATION
 NOT TO SCALE

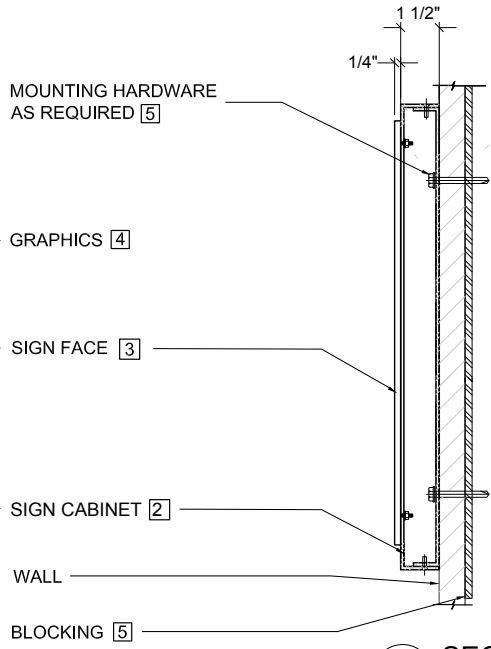

2 SECTION DETAIL
 NOT TO SCALE

Pedestrian Directional – Small Overhead

Sign Type Design

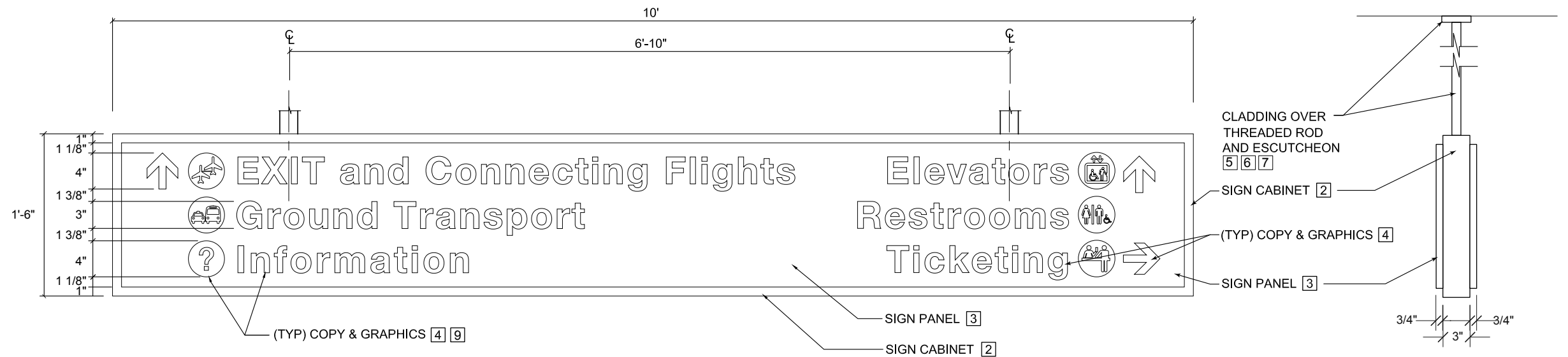
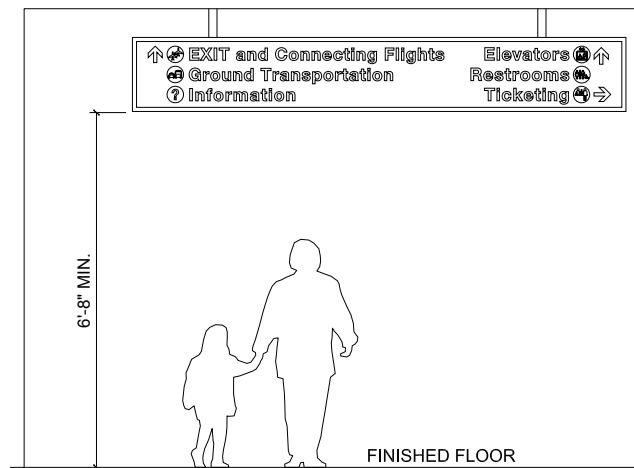

1 FRONT ELEVATION
NOT TO SCALE

2 SIDE ELEVATION
NOT TO SCALE

GENERAL NOTES:

1. DOUBLE-FACED, NON-ILLUMINATED, CEILING MOUNTED SIGN CABINET.
2. FABRICATED SIGN CABINET WITH INTERNAL FRAMING AS REQUIRED.
3. SIGN PANEL TO BE 3/4" DEEP FABRICATED ALUMINUM WITH PAINT FINISH AS NOTED.
4. COPY AND GRAPHICS TO BE VINYL DIE CUT IN COLORS INDICATED ON DRAWING.
5. COORDINATE WITH GENERAL CONTRACTOR TO PROVIDE ADDITIONAL SIGNAGE SUPPORT AS REQUIRED.
6. DESIGNER TO FIELD VERIFY AND DETERMINE BEST METHOD OF INSTALLATION WITH MINIMAL VISUAL IMPACT. DESIGNER TO PROVIDE STRUCTURAL ENGINEERING CALCULATIONS AS REQUIRED AND COORDINATE WITH GENERAL CONTRACTOR FOR STRUCTURAL REQUIREMENTS.
7. VERTICAL SUPPORTS WITH DECORATIVE CLADDING AS REQUIRED. PROVIDE SMALLEST DIAMETER AS ALLOWED BY STRUCTURAL ENGINEERING CALCULATIONS.
8. SIGNAGE SHOWN IS FOR PLACEMENT PURPOSES ONLY. FINAL MESSAGE AND LOCATION OF SIGN TO BE PROVIDED BY LAWA.

NOTE:

THE SCALE OF THE SIGNAGE AND GRAPHICS ARE SUBJECT TO CHANGE IN ORDER TO BE COMPLIANT WITH ADA GUIDELINES IF THE INSTALLATION SITE EXCEEDS THE HEIGHT SHOWN IN THE DRAWING PROVIDED.



GENERAL NOTES:

1. SINGLE-FACED, NON-ILLUMINATED, WALL MOUNTED SIGN CABINET.
2. FABRICATED SIGN CABINET WITH INTERNAL FRAMING AS REQUIRED.
3. SIGN PANEL TO BE 3/4" DEEP FABRICATED ALUMINUM WITH PAINT FINISH AS NOTED.
4. COPY AND GRAPHICS TO BE VINYL DIE CUT IN COLORS INDICATED ON DRAWING.
5. DESIGNER TO FIELD VERIFY AND DETERMINE BEST METHOD OF INSTALLATION WITH MINIMAL VISUAL IMPACT. DESIGNER TO PROVIDE STRUCTURAL ENGINEERING CALCULATIONS AS REQUIRED AND COORDINATE WITH GENERAL CONTRACTOR FOR STRUCTURAL REQUIREMENTS.
6. FIELD VERIFY EXISTING CONDITIONS PRIOR TO FABRICATION OF SIGN.
7. SIGNAGE SHOWN IS FOR PLACEMENT PURPOSES ONLY. FINAL MESSAGE AND LOCATION OF SIGN TO BE PROVIDED BY LAWA.

NOTE:

THE SCALE OF THE SIGNAGE AND GRAPHICS ARE SUBJECT TO CHANGE IN ORDER TO BE COMPLIANT WITH ADA GUIDELINES IF THE INSTALLATION SITE EXCEEDS THE HEIGHT SHOWN IN THE DRAWING PROVIDED.

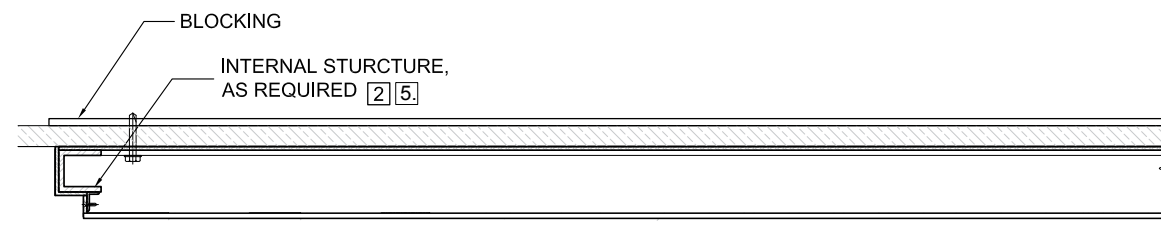

3 PARTIAL SECTION DETAIL
NOT TO SCALE

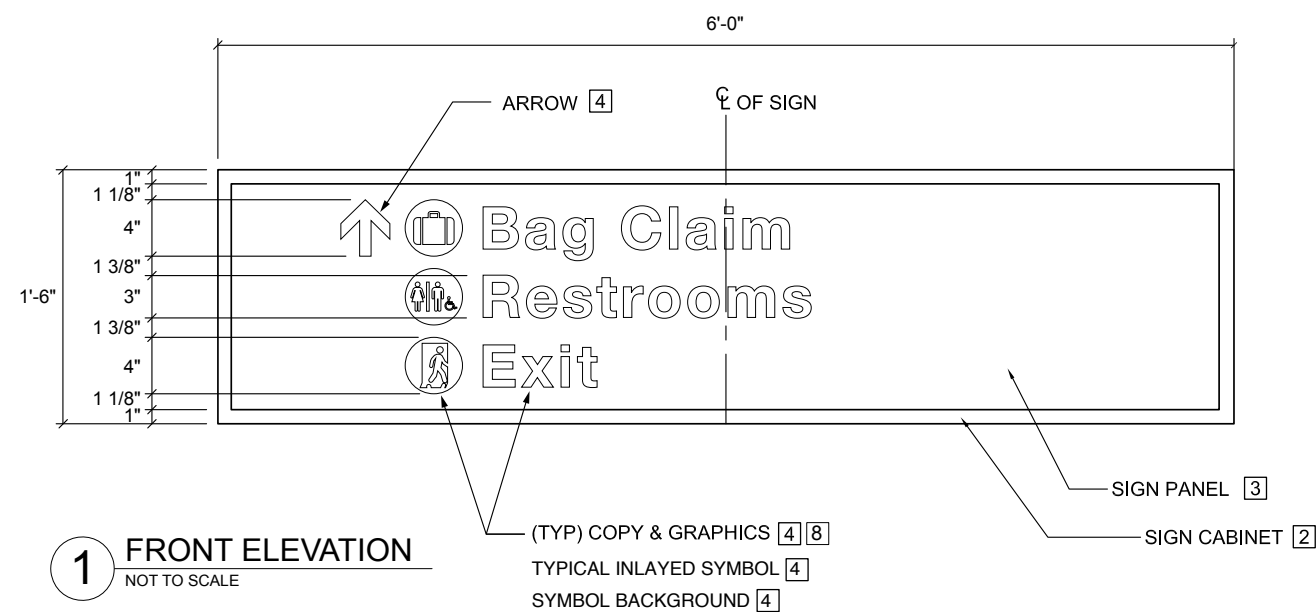
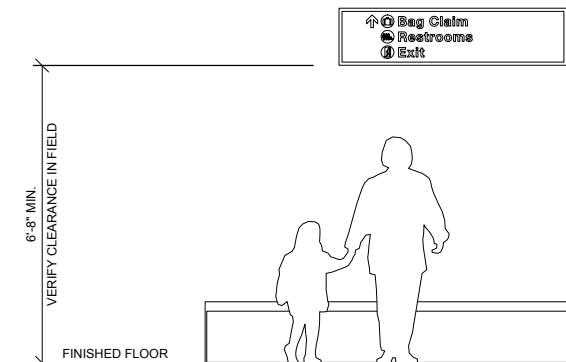

1 FRONT ELEVATION
NOT TO SCALE

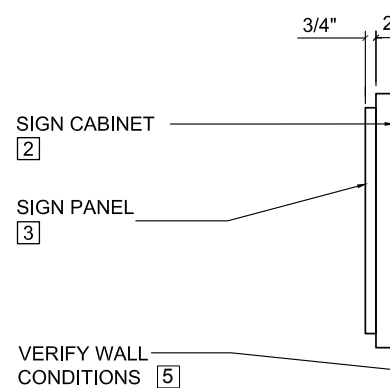

2 SIDE ELEVATION
NOT TO SCALE



GENERAL NOTES:

1. WALL MOUNTED PLAQUE WITH PAINTED BACKGROUND AND SCREENED GRAPHICS.
2. SIGN PANEL TO BE 1/8" THICK BRUSHED ALUMINUM WITH MASKED AND PAINTED BACKGROUND.
3. COPY TO BE VINYL DIE-CUT WITH COLOR TO MATCH AS INDICATED ON DRAWING.
4. FLUSH MOUNT ONTO EXISTING INTERIOR WALL WITH SILICONE ADHESIVE AND VHB TAPE AS REQUIRED.
5. LAWA TO PROVIDE SPECIFIC MESSAGE PER LOCATION OF SIGN.

NOTE:

THE SCALE OF THE SIGNAGE AND GRAPHICS ARE SUBJECT TO CHANGE IN ORDER TO BE COMPLIANT WITH ADA GUIDELINES IF THE INSTALLATION SITE EXCEEDS THE HEIGHT SHOWN IN THE DRAWING PROVIDED.

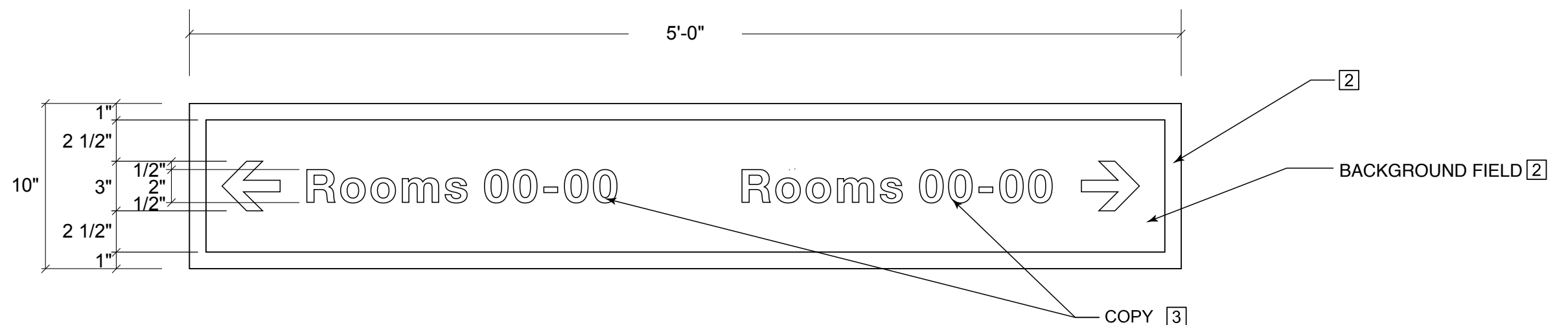
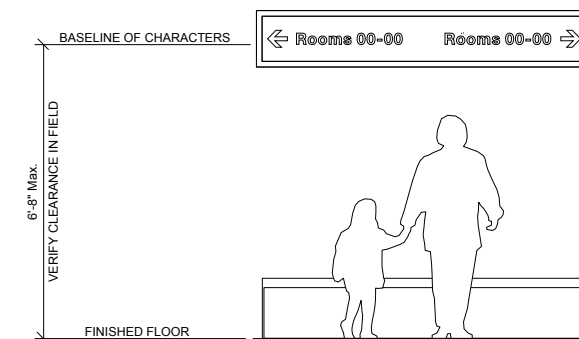

1 FRONT ELEVATION
NOT TO SCALE



GENERAL NOTES:

1. NON-ILLUMINATED, WALL MOUNTED FABRICATED ALUMINUM SIGN CABINET.
2. ALUMINUM SIGN CABINET TO BE FABRICATED IN A MANNER TO ALLOW EASE OF MAINTENANCE. PROVIDE INTERNAL SUPPORT AS REQUIRED.
3. SIGN FACE TO BE PAINTED ALUMINUM ATTACHED TO SIGN CABINET WITH BLIND FASTENERS.
4. COPY AND GRAPHICS TO BE VINYL DIE-CUT IN COLOR INDICATED ON DRAWING.
5. VERIFY EXISTING CONDITIONS PRIOR TO FABRICATION OF SIGN. COORDINATE WITH GENERAL CONTRACTOR TO PROVIDE ADDITIONAL BLOCKING AS REQUIRED. CONNECTION DETAILS AND STRUCTURAL CALCULATIONS TO BE VERIFIED BY STRUCTURAL ENGINEERING CALCULATIONS.
6. VERIFY FINAL MESSAGE AND LOCATION OF SIGN WITH LAWA.

NOTE:
THE SCALE OF THE SIGNAGE AND GRAPHICS ARE SUBJECT TO CHANGE IN ORDER TO BE COMPLIANT WITH ADA GUIDELINES IF THE INSTALLATION SITE EXCEEDS THE HEIGHT SHOWN IN THE DRAWING PROVIDED.

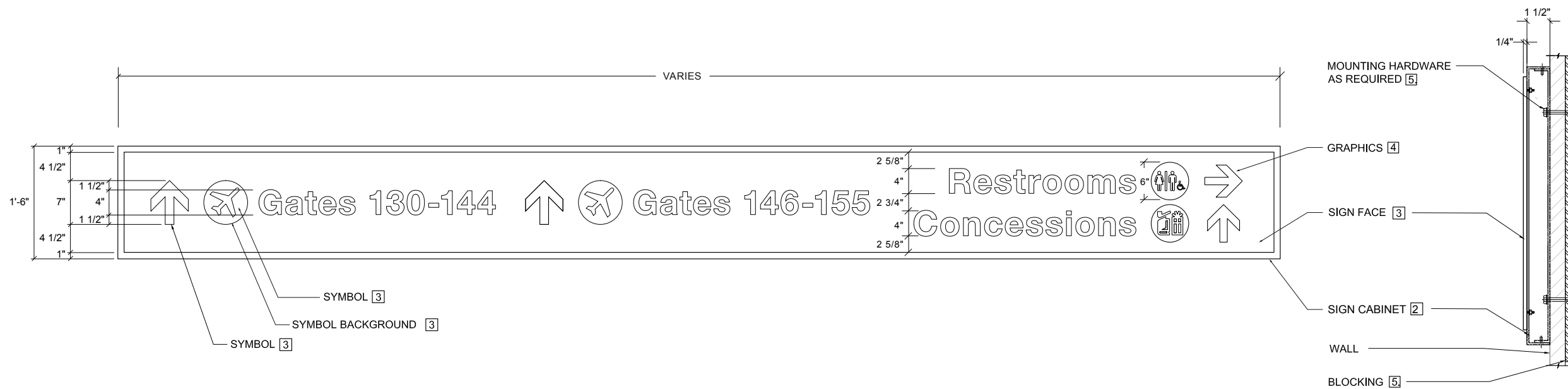
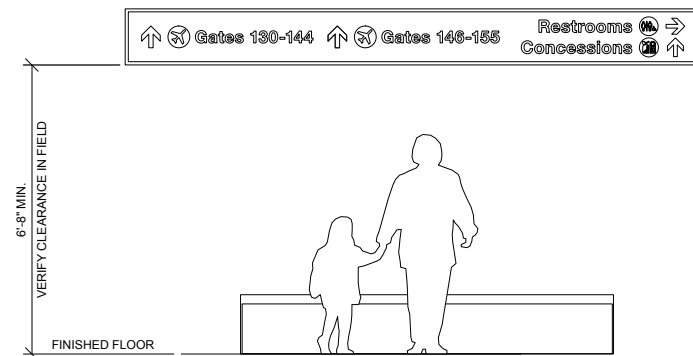

1 FRONT ELEVATION
NOT TO SCALE

2 SECTION DETAIL
NOT TO SCALE

GENERAL NOTES:

1. WALL MOUNTED PLAQUE WITH PAINTED BACKGROUND OR SCREENED GRAPHICS.
2. SIGN PANEL TO BE 1/8" THICK PHOTOPOLYMER COLOR TO MATCH THE SCREEN PRINTED GRAPHICS.
3. FLUSH MOUNT ONTO EXISTING INTERIOR WALL WITH SILICONE ADHESIVE AND VHB TAPE AS REQUIRED.
4. TYPESTYLE: HELVETICA NEUE LT PRO 65 MEDIUM.
5. LAWA TO PROVIDE SPECIFIC MESSAGE PER LOCATION OF SIGN.

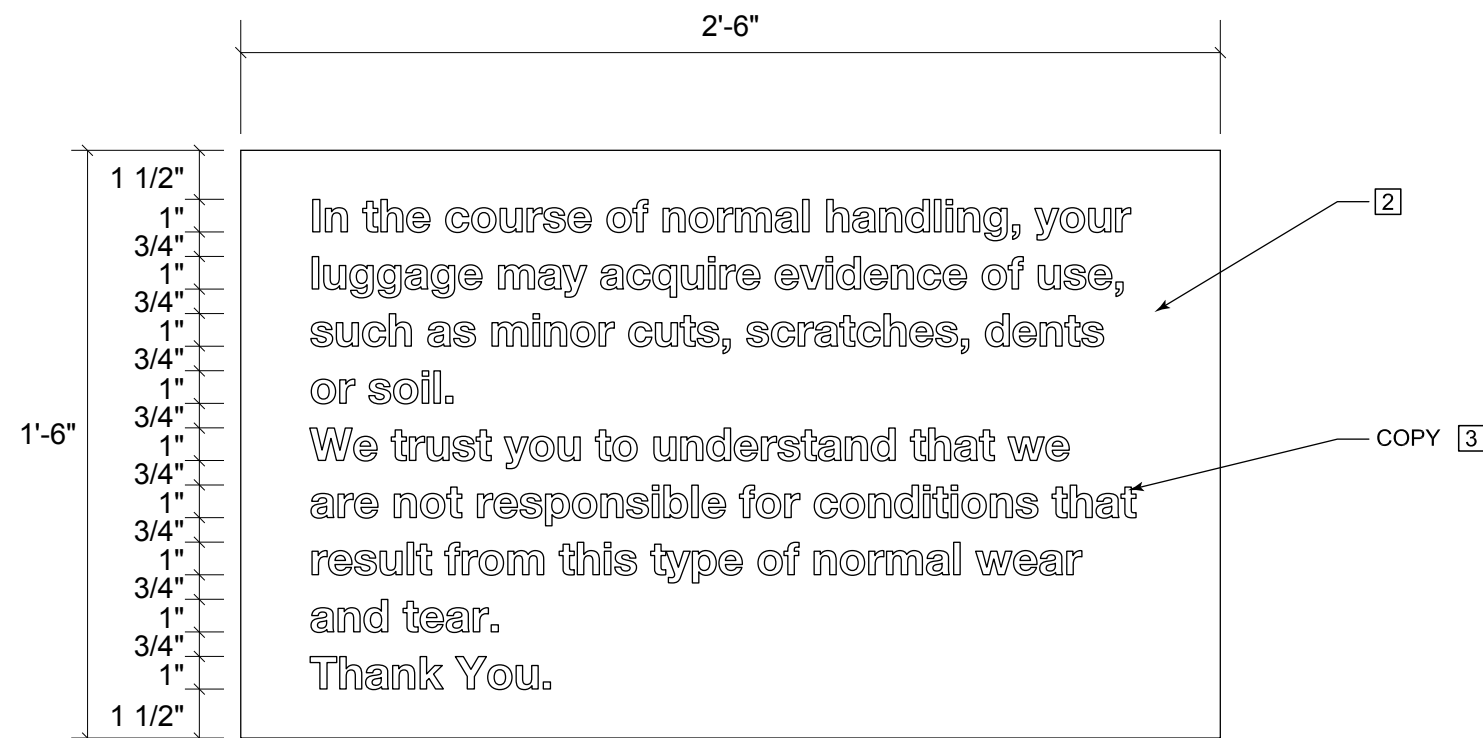

1 FRONT ELEVATION
NOT TO SCALE

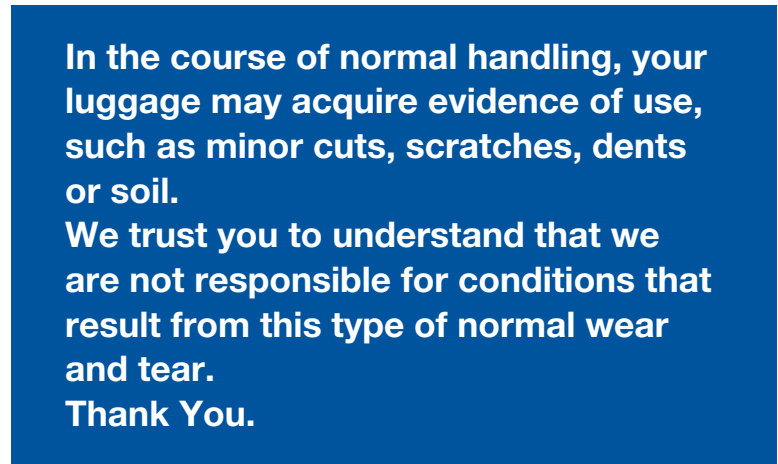

GENERAL NOTES:

1. WALL MOUNTED PLAQUE WITH PAINTED BACKGROUND OR SCREENED GRAPHICS.
2. SIGN PANEL TO BE 1/8" THICK PHOTOPOLYMER COLOR TO MATCH THE SCREEN PRINTED GRAPHICS.
3. FLUSH MOUNT ONTO EXISTING INTERIOR WALL WITH SILICONE ADHESIVE AND VHB TAPE AS REQUIRED.
4. TYPESTYLE: HELVETICA NEUE LT PRO 65 MEDIUM.
5. LAW TO PROVIDE SPECIFIC MESSAGE PER LOCATION OF SIGN.

NOTE:
VARIANCES

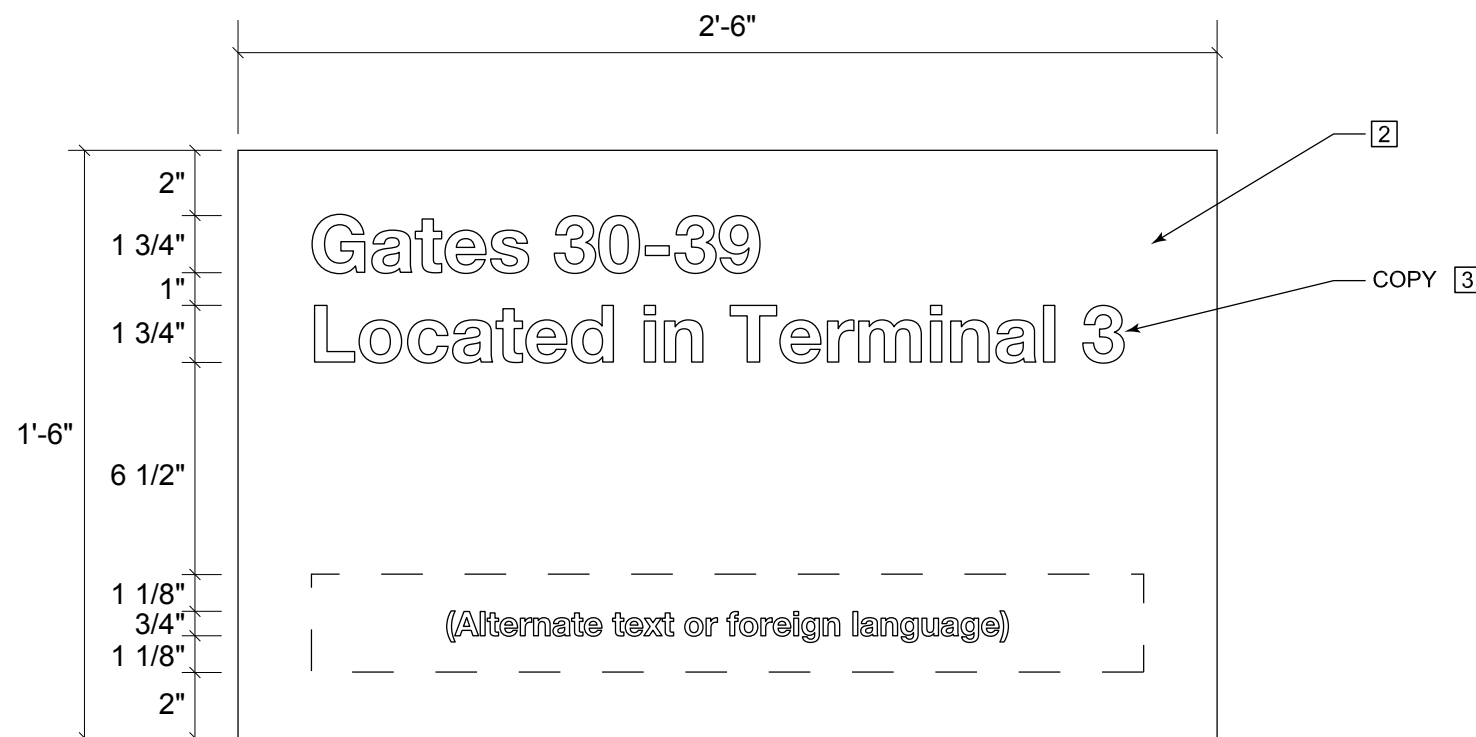

1 FRONT ELEVATION
NOT TO SCALE

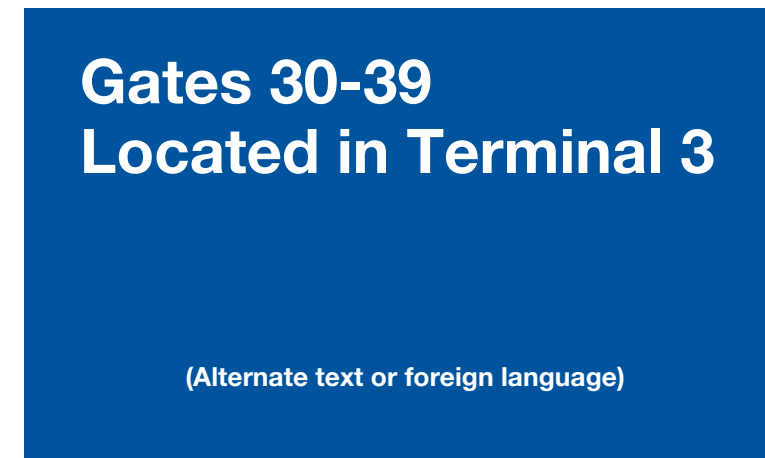

Sign Type Design

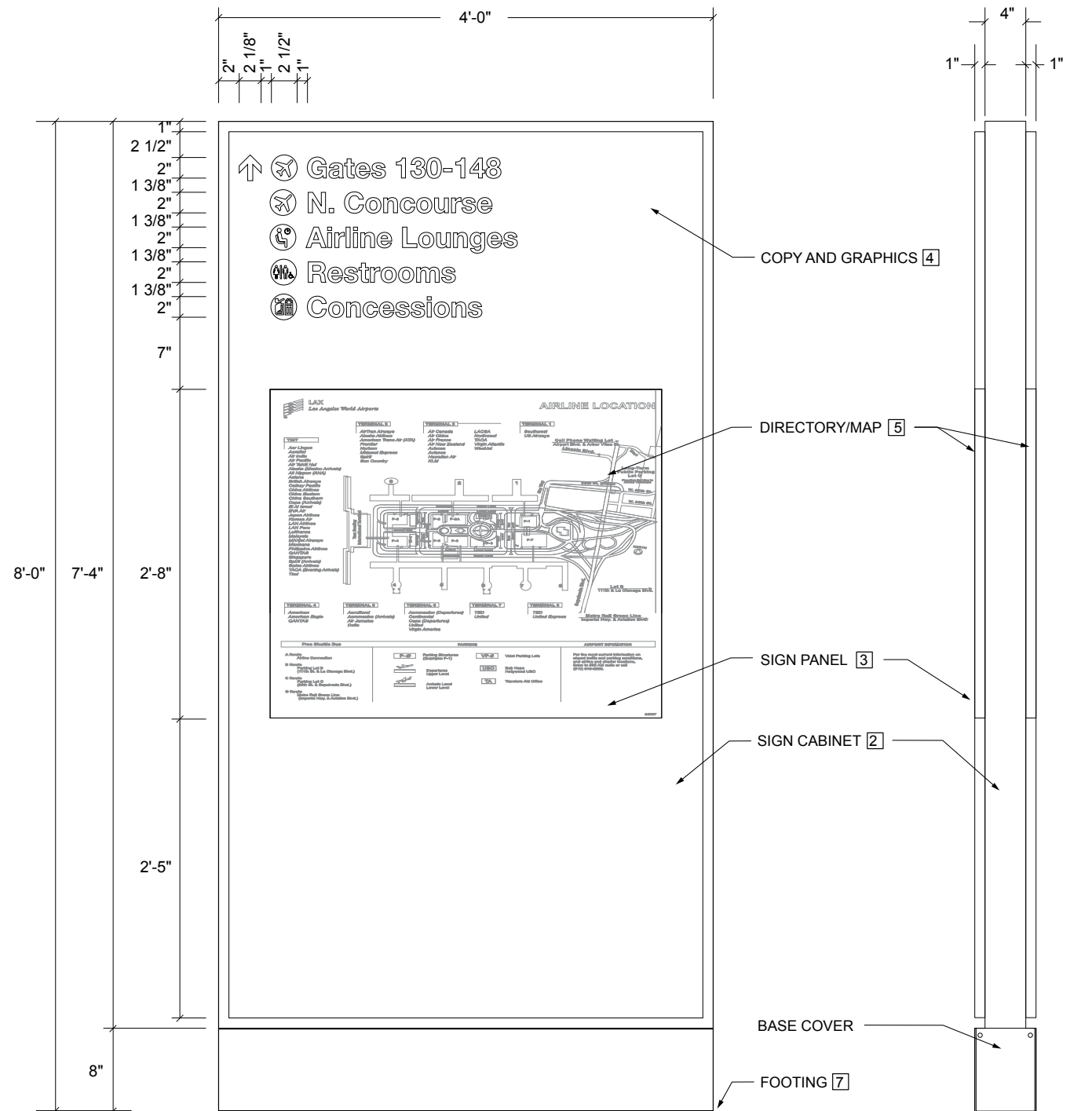

1 FRONT ELEVATION
NOT TO SCALE

2 SIDE ELEVATION
NOT TO SCALE

GENERAL NOTES:

- 1 DOUBLE-FACED, NON ILLUMINATED, FREESTANDING PYLON SIGN WITH REPLACEABLE MAP DIRECTORY.
- 2 FABRICATED ALUMINUM CABINET WITH INTERNAL STRUCTURE AS REQUIRED.
- 3 SIGN PANELS TO BE FABRICATED ALUMINUM PAINTED IN COLOR INDICATED. ATTACH TO SIGN CABINET IN AN INCONSPICUOUS MANNER.
- 4 COPY AND GRAPHICS TO BE VINYL DIE-CUT TO MATCH COLORS INDICATED ON DRAWING.
- 5 LED DISPLAY SPECIFICATIONS TO BE APPROVED BY LAWA. PROVIDE MANUFACTURER'S REQUIREMENTS FOR VENTILATION IN SIGN CABINET. ALLOW FOR EASE OF MAINTENANCE WITH INCONSPICUOUS ACCESS PANELS.
- 6 DESIGNER TO FIELD VERIFY EXISTING CONDITIONS AND COORDINATE WITH GENERAL CONTRACTOR FOR BEST METHOD OF INSTALLATION. DESIGNER TO PROVIDE STRUCTURAL AND FOOTING REQUIREMENTS BASED ON STRUCTURAL ENGINEERING CALCULATIONS.
- 7 LAYOUT SHOWN IS FOR PLACEMENT PURPOSES ONLY. LAWA TO PROVIDE SPECIFIC MESSAGES PER SIGN LOCATION.

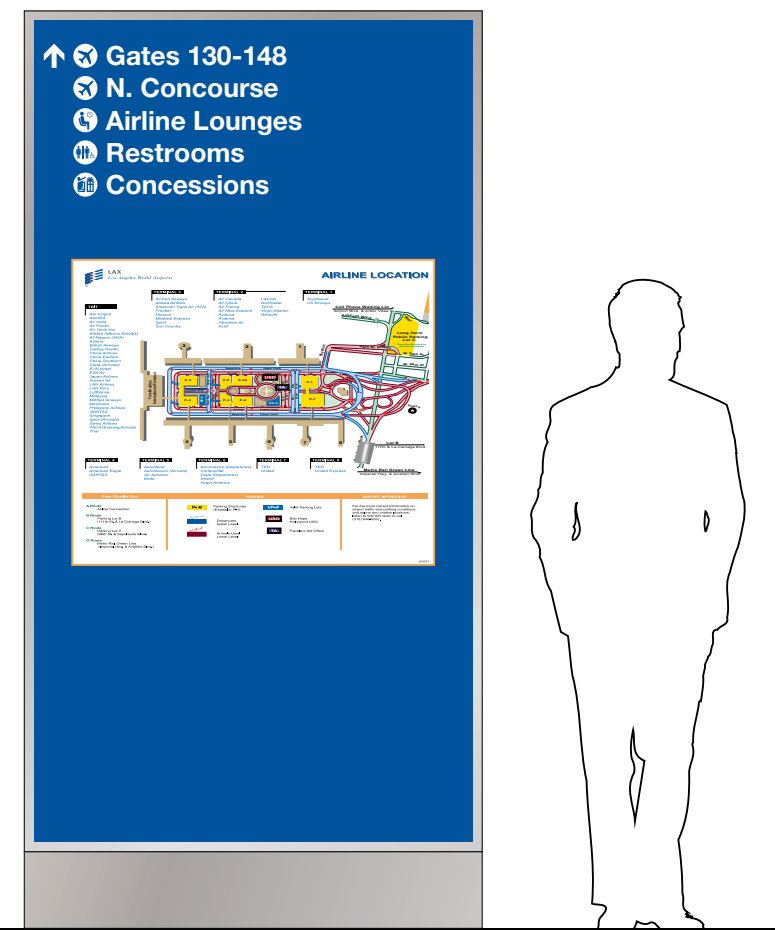

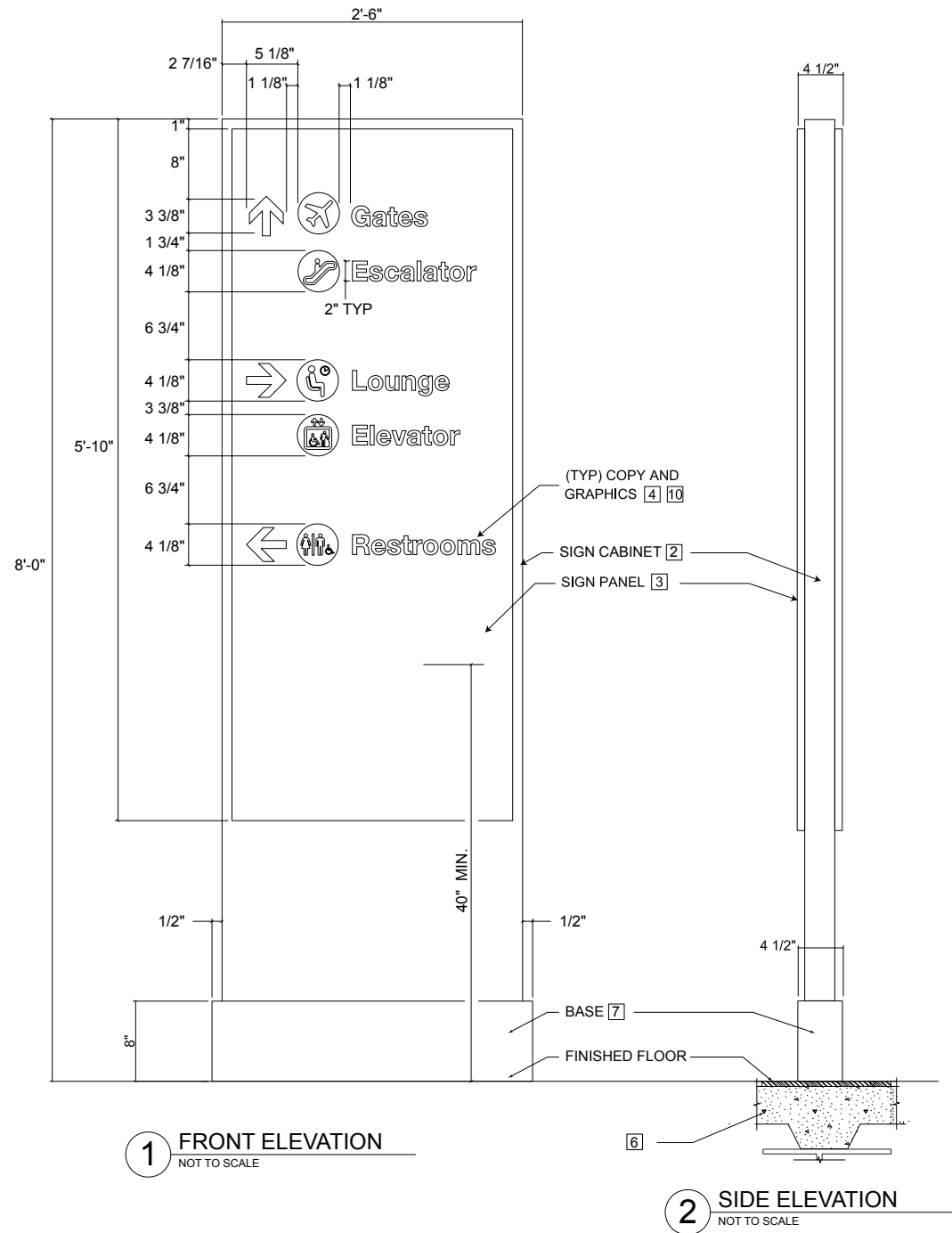

GENERAL NOTES:

1. DOUBLE-FACED, NON ILLUMINATED, FREESTANDING PYLON SIGN WITH VINYL COPY.
2. FABRICATED ALUMINUM CABINET WITH INTERNAL STRUCTURE AS REQUIRED.
3. SIGN PANELS TO BE FABRICATED ALUMINUM PAINTED IN COLOR INDICATED. ATTACH TO SIGN CABINET IN AN INCONSPICUOUS MANNER.
4. COPY AND GRAPHICS TO BE VINYL DIE-CUT APPLIED TO SIGN PANEL.
5. FIELD VERIFY EXISTING CONDITIONS. COORDINATE WITH GENERAL CONTRACTOR FOR BEST METHOD OF INSTALLATION. PROVIDE STRUCTURAL AND FOOTING REQUIREMENTS BASED ON STRUCTURAL ENGINEERING CALCULATIONS.
6. DESIGNER TO FIELD VERIFY AND DETERMINE BEST METHOD OF INSTALLATION WITH MINIMAL VISUAL IMPACT. DESIGNER TO PROVIDE STRUCTURAL ENGINEERING CALCULATIONS AS REQUIRED AND COORDINATE WITH GENERAL CONTRACTOR FOR STRUCTURAL REQUIREMENTS.
7. FABRICATED BASE COVER TO BE FABRICATED IN A MANNER TO WITHSTAND ABUSE FROM LUGGAGE CARTS.
8. MESSAGES SHOWN ARE FOR PLACEMENT PURPOSES ONLY. LAWA TO PROVIDE SPECIFIC MESSAGES PER SIGNAGE LOCATION.

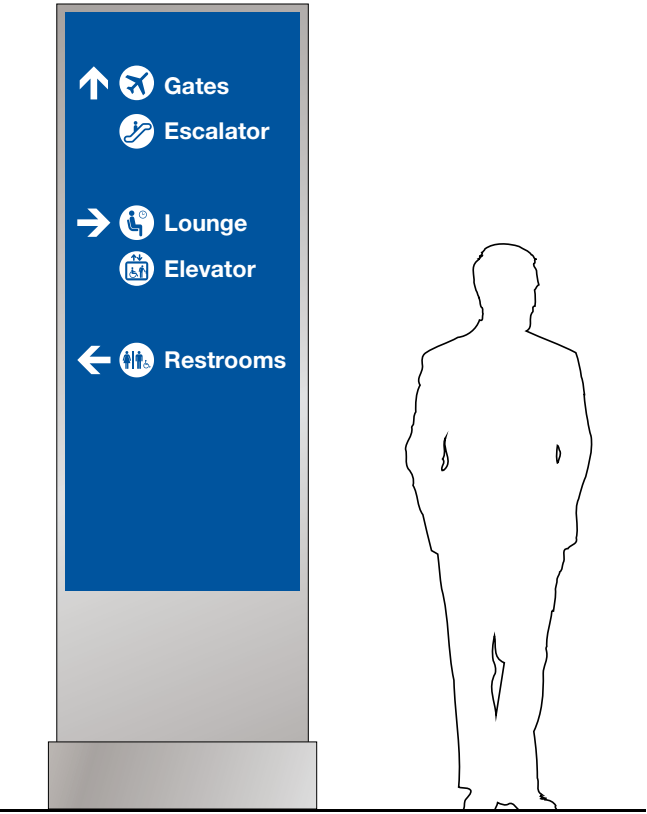

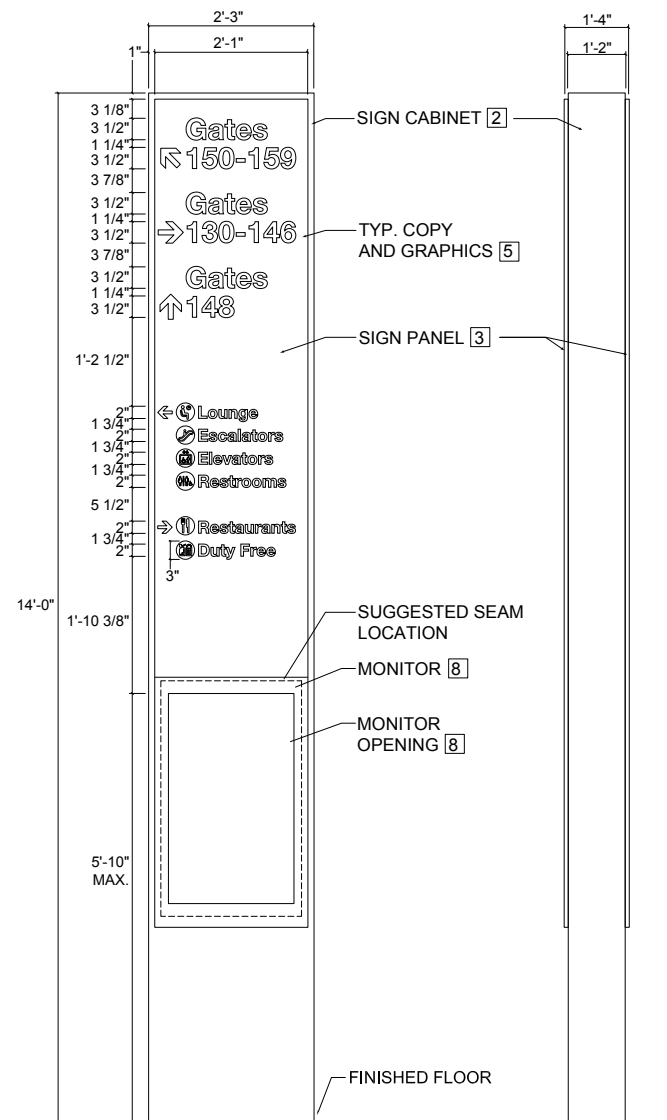
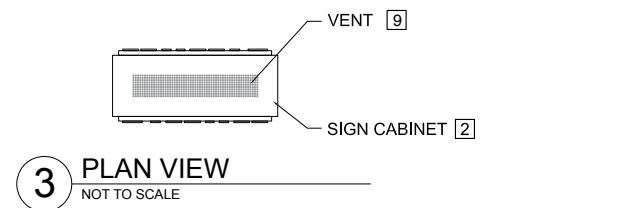

1 ELEVATION (SIDE A)
NOT TO SCALE

2 END ELEVATION
NOT TO SCALE

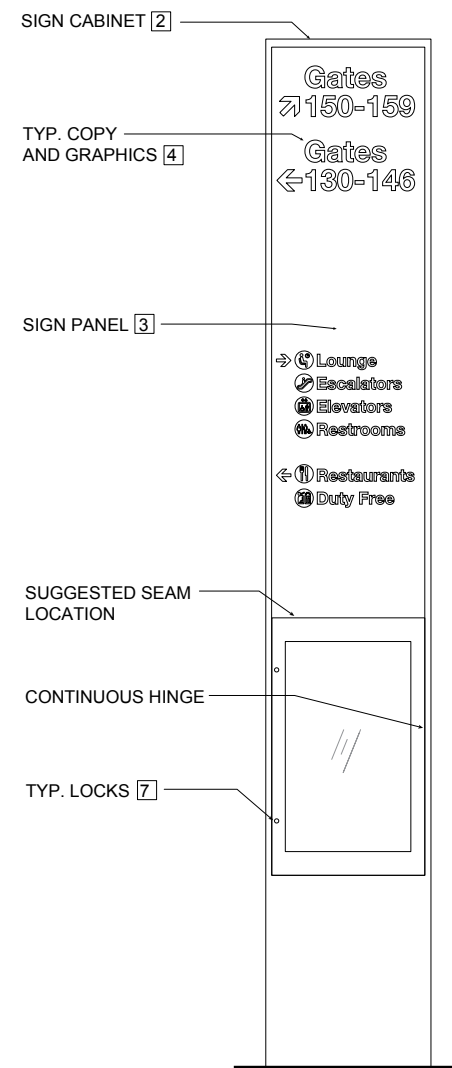

4 ELEVATION (SIDE B)
NOT TO SCALE

GENERAL NOTES:

1. DOUBLE-FACED, NON ILLUMINATED, FREESTANDING PYLON SIGN WITH MONITOR, POSTER CABINET AND VINYL COPY.
2. FABRICATED ALUMINUM CABINET WITH INTERNAL STRUCTURE AS REQUIRED.
3. SIGN PANELS TO BE FABRICATED ALUMINUM PAINTED IN COLOR INDICATED. ATTACH TO SIGN CABINET IN AN INCONSPICUOUS MANNER.
4. COPY AND GRAPHICS TO BE VINYL DIE-CUT APPLIED TO SIGN PANEL.
5. FIELD VERIFY EXISTING CONDITIONS. COORDINATE WITH GENERAL CONTRACTOR FOR BEST METHOD OF INSTALLATION. PROVIDE STRUCTURAL AND FOOTING REQUIREMENTS BASED ON STRUCTURAL ENGINEERING CALCULATIONS.
6. LED DISPLAY SPECIFICATIONS TO BE APPROVED BY LAWA. PROVIDE MANUFACTURER'S REQUIREMENTS FOR VENTILATION IN SIGN CABINET. ALLOW FOR EASE OF MAINTENANCE WITH INCONSPICUOUS ACCESS PANELS.
7. POSTER RETAINER TO BE TEMPERED GLASS WITH FABRICATED FRAME TO MATCH SIGN PANEL. PROVIDE CONTINUOUS HINGE AND TWO LOCKS KEYED ALIKE. PROVIDE TOOL-LESS FASTENERS AND BACKER PANEL TO RETAIN POSTER.
8. MONITOR TO BE PROVIDED BY LAWA. INSTALL IN A MANNER TO ALLOW EASE OF MAINTENANCE. FOLLOW MANUFACTURERS RECOMMENDATIONS FOR INSTALLATION INCLUDING VENTILATION REQUIREMENTS.
9. DESIGNER TO FIELD VERIFY AND DETERMINE BEST METHOD OF INSTALLATION WITH MINIMAL VISUAL IMPACT. DESIGNER TO PROVIDE STRUCTURAL ENGINEERING CALCULATIONS AS REQUIRED AND COORDINATE WITH GENERAL CONTRACTOR FOR STRUCTURAL REQUIREMENTS.
10. ESTIMATED SIGN WATTAGE REQUIREMENTS: 2500W
ESTIMATED SIGN WEIGHT: 1200 LBS.
11. MESSAGES SHOWN ARE FOR PLACEMENT PURPOSES ONLY. LAWA TO PROVIDE SPECIFIC MESSAGES PER SIGNAGE LOCATION.

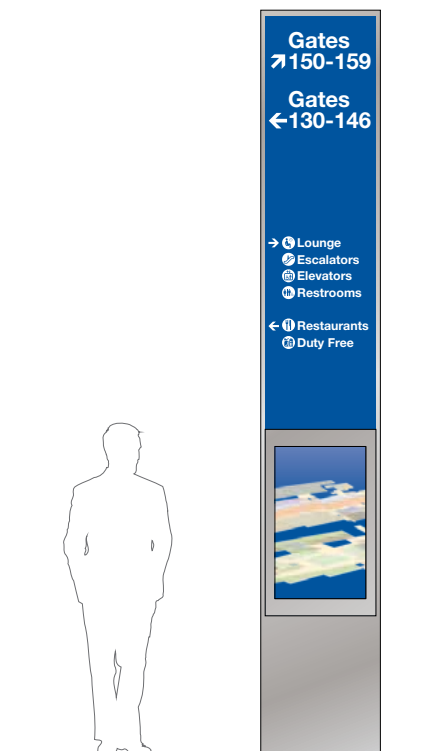

OPTION 1

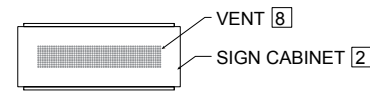

3 TOP VIEW
NOT TO SCALE

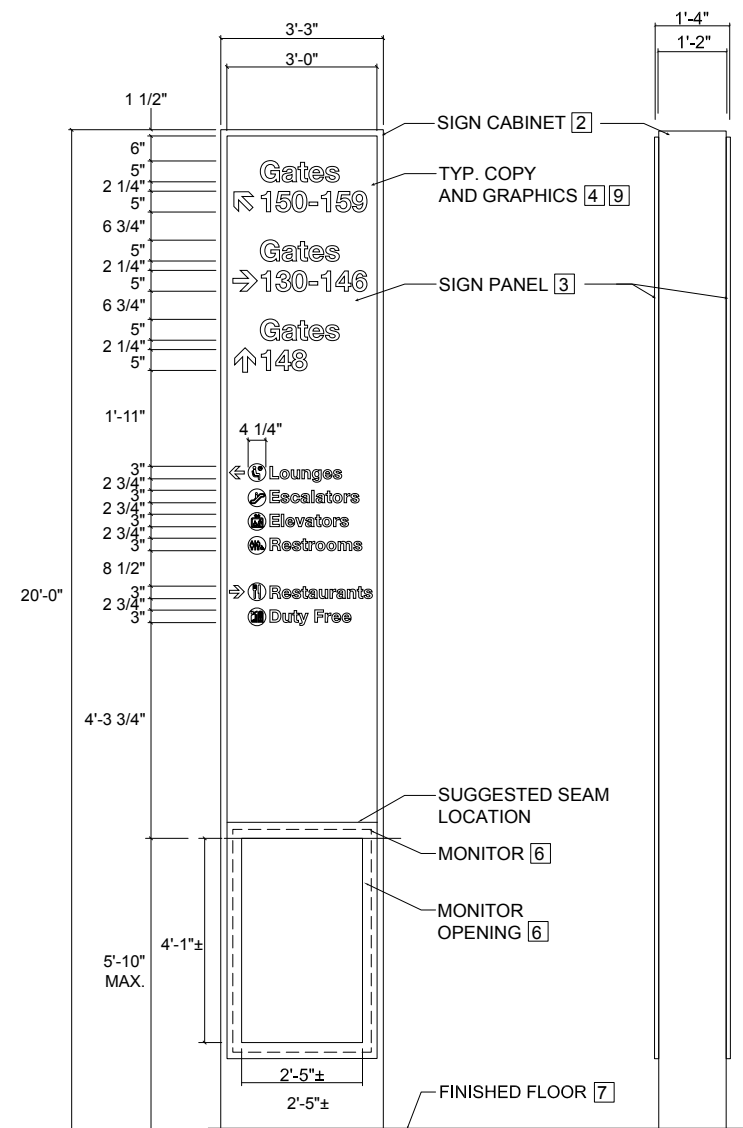

1 ELEVATION (SIDE A)
NOT TO SCALE

2 END ELEVATION
NOT TO SCALE

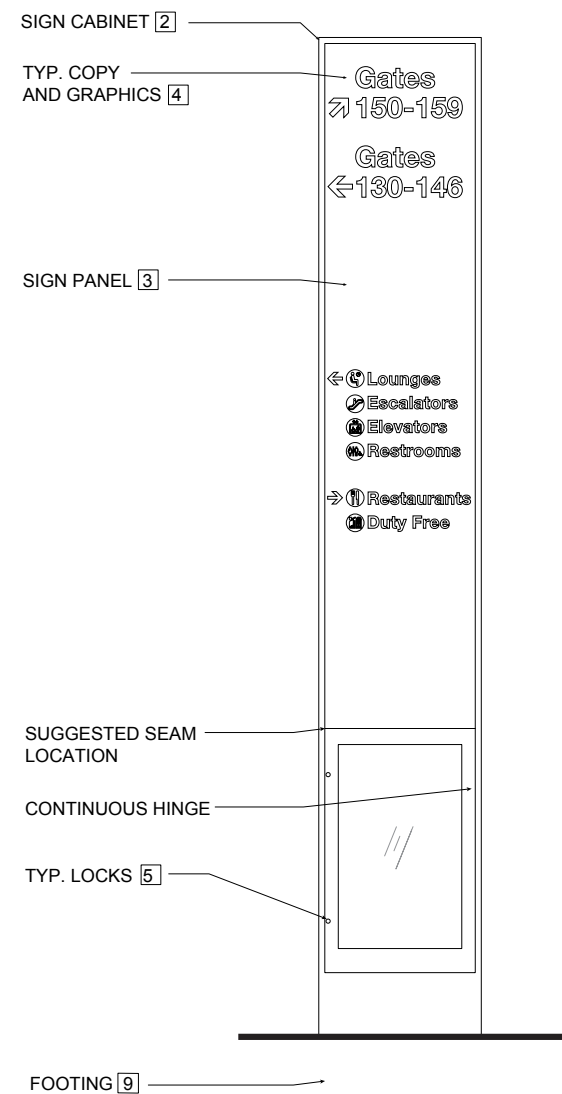

4 ELEVATION (SIDE B)
NOT TO SCALE

GENERAL NOTES:

1. DOUBLE-FACED, NON ILLUMINATED, FREESTANDING PYLON SIGN WITH MONITOR, POSTER CABINET AND VINYL COPY.
2. FABRICATED ALUMINUM CABINET WITH INTERNAL STRUCTURE AS REQUIRED.
3. SIGN PANELS TO BE FABRICATED ALUMINUM PAINTED IN COLOR INDICATED. ATTACH TO SIGN CABINET IN AN INCONSPICUOUS MANNER.
4. COPY AND GRAPHICS TO BE VINYL DIE-CUT APPLIED TO SIGN PANEL.
5. POSTER RETAINER TO BE TEMPERED GLASS WITH FABRICATED FRAME TO MATCH SIGN PANEL. PROVIDE CONTINUOUS HINGE AND TWO LOCKS KEYED ALIKE. PROVIDE TOOL-LESS FASTENERS AND BACKER PANEL TO RETAIN POSTER.
6. LED DISPLAY SPECIFICATIONS TO BE APPROVED BY LAWA. PROVIDE MANUFACTURER'S REQUIREMENTS FOR VENTILATION IN SIGN CABINET. ALLOW FOR EASE OF MAINTENANCE WITH INCONSPICUOUS ACCESS PANELS.
7. DESIGNER TO FIELD VERIFY AND DETERMINE BEST METHOD OF INSTALLATION WITH MINIMAL VISUAL IMPACT. DESIGNER TO PROVIDE STRUCTURAL ENGINEERING CALCULATIONS AS REQUIRED AND COORDINATE WITH GENERAL CONTRACTOR FOR STRUCTURAL REQUIREMENTS.
8. ESTIMATED SIGN WATTAGE REQUIREMENTS: 2500W
ESTIMATED SIGN WEIGHT: 1200 LBS.
9. MESSAGES SHOWN ARE FOR PLACEMENT PURPOSES ONLY. LAWA TO PROVIDE SPECIFIC MESSAGES PER SIGNAGE LOCATION.

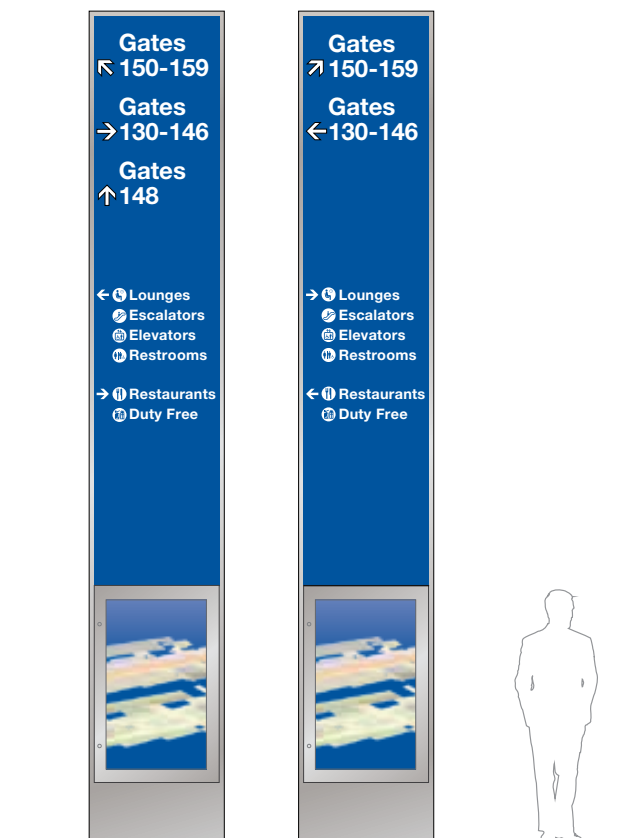

OPTION 2

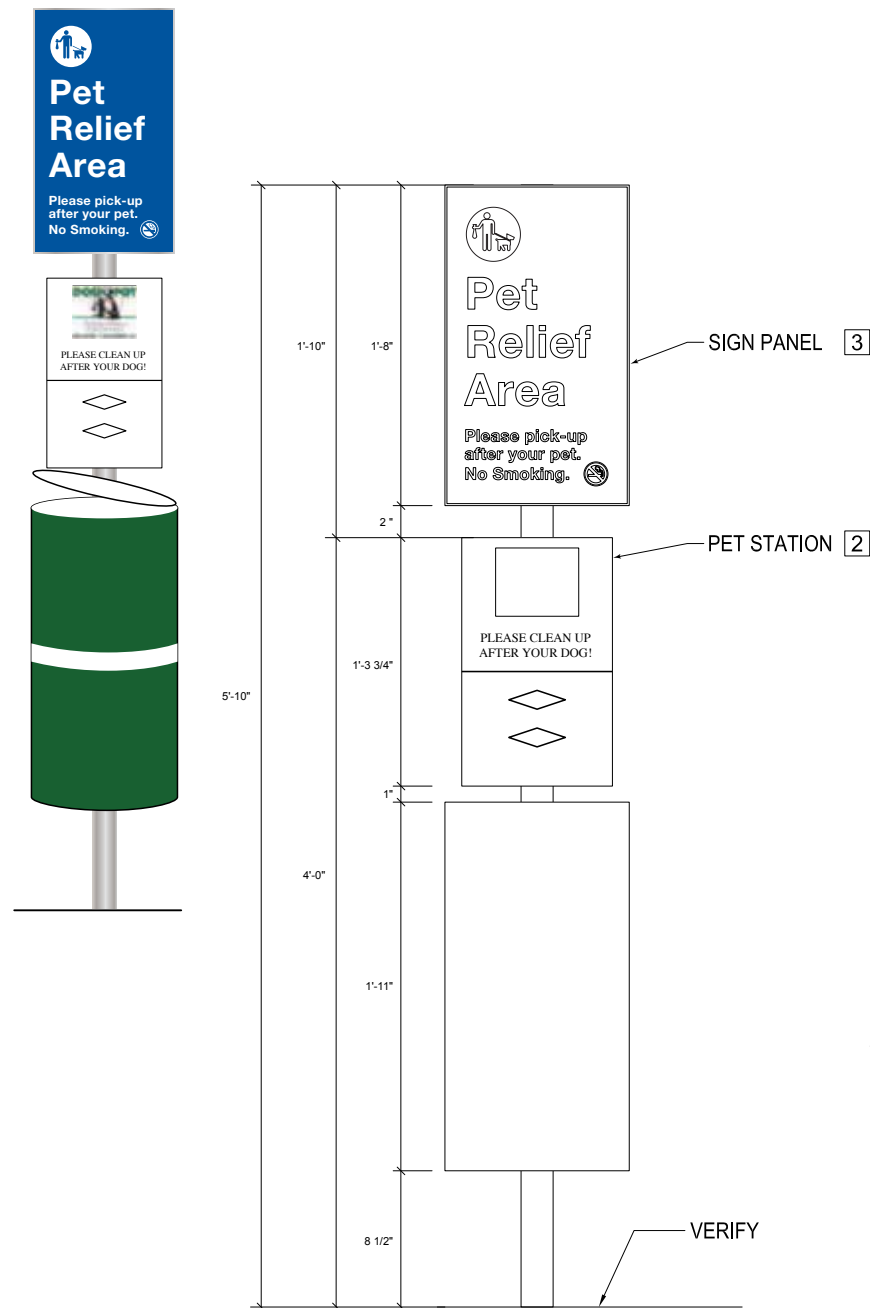

1 FRONT ELEVATION
NOT TO SCALE

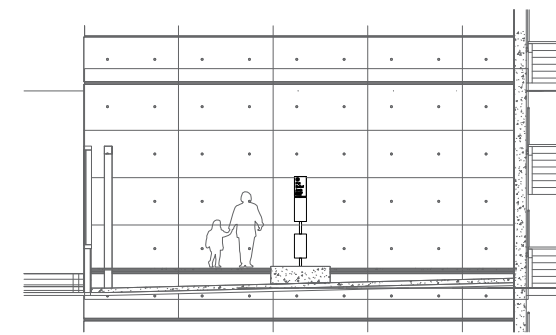

3 CONTEXT ELEVATION
NOT TO SCALE

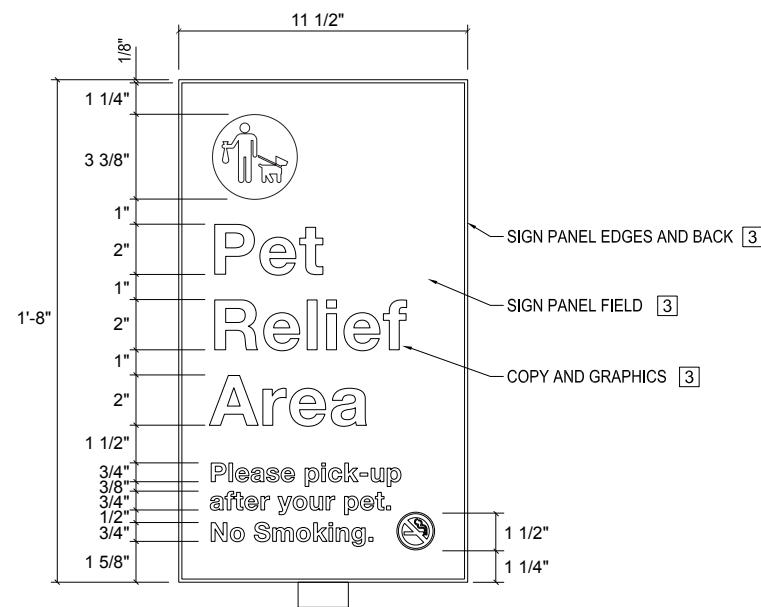

2 SIGN PANEL
NOT TO SCALE

GENERAL NOTES:

1. PURCHASE AND INSTALL PET STATION AND FABRICATE AND INSTALL TOP SIGN PANEL AS NOTED.
2. PURCHASE PET STATION AS NOTED. PROVIDE FOOTING TO RECEIVE TELESCOPIC POST AS REQUIRED.
3. SIGN PANEL TO BE 1/8" PANEL WITH SCREEN PRINTED GRAPHICS AS NOTED.
4. DESIGNER TO FIELD VERIFY AND DETERMINE BEST METHOD OF INSTALLATION WITH MINIMAL VISUAL IMPACT. DESIGNER TO PROVIDE STRUCTURAL ENGINEERING CALCULATIONS AS REQUIRED AND COORDINATE WITH GENERAL CONTRACTOR FOR FOOTING REQUIREMENTS.

**ALUMINUM DOGIPOT PET STATION
SPECIFICATION, INSTALLATION AND OPERATION SHEET
[Item # 1003-L]**

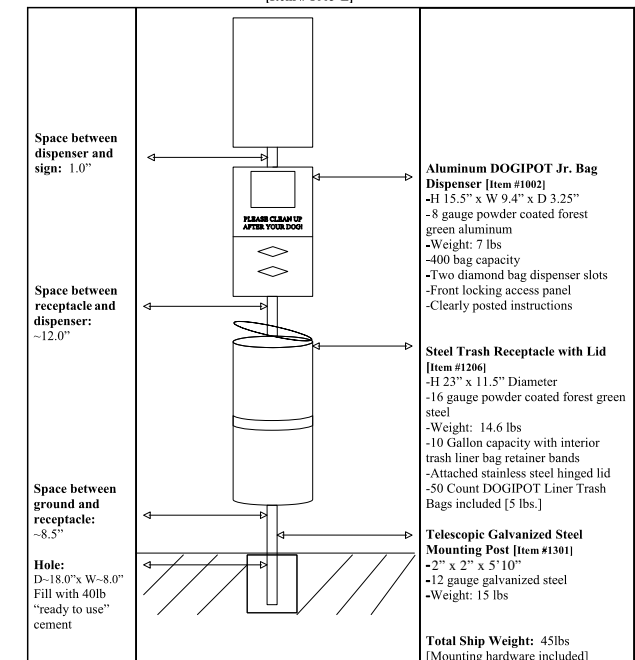

Product Profile

- 135-1003 Pet Waste Station with "Please Clean Up After Your Pet" Sign**
- Encourage hygienic disposal of dog and pet waste by providing a convenient bag-dispensing and disposal center. Complete station includes:
- Bag Dispenser
 - Waste Receptacle
 - Degradable Litter Bags (2 Rolls @200 bags each - opaque brown 13" x 8")
 - 1 Roll 50 Heavy-Duty Trash Liner Bags
 - 4'-8" Post
 - Reflective Easy-To-Read Sign - 18" x 12" Aluminum
 - Assembly Material

Order refills as required. Unlike time-consuming cleaning of dog walk areas, containers can be conveniently emptied at the same time as the scheduled trash collect